



OEM INSTRUCTION MANUAL

pCO⁵/pGD DIGITAL CONTROLLER

HEAT PUMPS

AirMaster, AquaMaster, EasyMaster, BoxAir

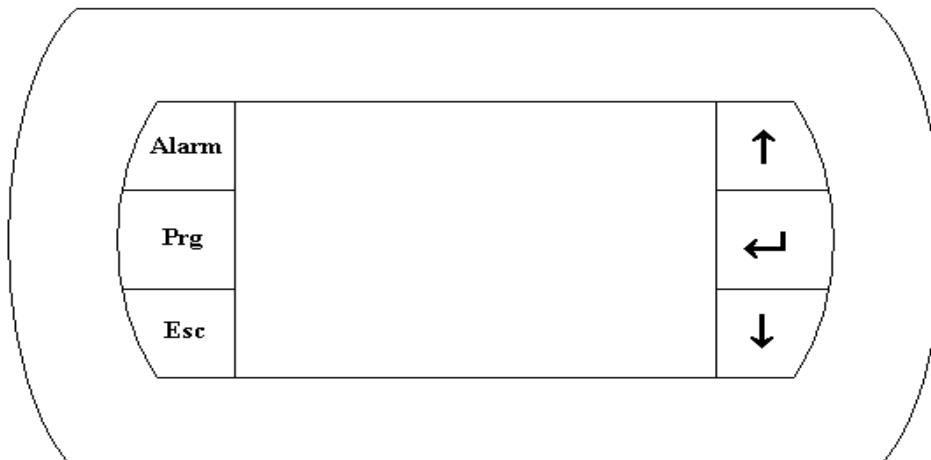

TABLE OF CONTENTS:

1	Introduction	7
2	Visual display unit	7
2.1	Display unit	7
2.2	Denotation and functions of keyboard keys and backlighting	7
2.3	Language Change	8
3	Structure of the menu.....	8
3.1	Main screen	8
3.1.1	Operating Mode	8
3.1.2	Compressor Operation.....	9
3.1.3	Pump Operation.....	9
3.1.4	Fan/Brine Pump Operation	9
3.1.5	Defrost Mode	9
3.1.6	Electric Heater Operation and Safety Thermostat Activated	10
3.1.7	Outdoor Temperature	10
3.1.8	Temperature of Water.....	10
3.1.9	Sanitary Hot Water Temperature.....	10
3.1.10	Room Temperature.....	10
3.1.11	Electricity Tariff / Remote Off.....	10
3.1.12	Unit On/Off.....	10
3.2	Auxiliary screens.....	11
3.2.1	Setting Unit Operation.....	11
3.2.2	Sanitary Hot Water.....	12
3.2.3	Heating/Cooling	15
3.2.4	Room Terminal pADxx.....	18
3.2.5	Heating Circuits.....	22
3.2.6	Solar.....	25
3.2.7	Swimming Pool	26
3.2.8	Service Info	27
3.2.9	Clock	28
4	Alarms.....	31
4.1	Types of alarm	31
4.2	General Alarm Explanation.....	32
4.3	Detailed Alarm Displays.....	32
4.4	Warnings.....	33
4.5	To reset alarms.....	34
4.6	Manual reset	34
5	What to do if.....	35
5.1	After power is on, the backlighting of the ALR key flashes	35
5.2	The main screen with icons shows the symbol flashing.....	35
5.3	The symbol is lit.....	35
5.4	The backlighting of the ALARM key flashes	35
5.5	The ALARM key is lit steadily	35
5.6	Active icon.....	35
5.7	Defrosting icon flashes	35
5.8	Defrosting icon is steadily lit	35
5.9	E! appears on the Main Screen	36
5.10	Pump symbol is flashing on the Main Screen.....	36
6	Switchboard	37
6.1	AirMaster, EasyMaster, AquaMaster	37
6.2	BoxAir	38
6.3	Main switch	39
6.4	Control circuit breaker.....	39
6.5	Control Circuit Fuses	39
6.6	Auxiliary Heater Safety Thermostat.....	39
6.7	Emergency Auxiliary Heater Manual Thermostat.....	39
6.8	Auxiliary Heater Circuit Breaker.....	39
6.9	Compressor circuit breaker.....	39
7	Troubleshooting	40
7.1	Water/Water, Brine/Water Heat Pumps.....	40
7.2	Air/Water Heat Pumps	42
7.3	Reseting Circuit Breakers	44



7.4	Reseting the Auxiliary Heater Safety Thermostat.....	44
7.5	Defrost Cycle (Air/Water only)	44
7.5.1	Activating of the Manual Defrost.....	44
8	Declaration of Conformity.....	45
9	Safety and Environment Protection	47
9.1	Greenhouse Gas.....	47
9.2	Hermetical Sealing.....	47
10	Service Menu.....	48
10.1	Heating Set	49
10.1.1	Weather compensation Heating	49
10.1.2	Water/Air Limits Heating	53
10.1.3	Compressor Hysterezis / Offset Heating	54
10.1.4	Compressor limit	54
10.1.5	Auxiliary Heater Limit	55
10.1.6	Auxiliary Heater Control	55
10.1.7	Heater Antifreeze function	55
10.1.8	Auxiliary Heater HW config.....	56
10.1.9	Heating Control Logic	57
10.1.10	Geometric temperature	57
10.1.11	Automatic Changeover	58
10.2	Cooling Set	59
10.2.1	Weather compensation Cooling.....	59
10.2.2	Water/Air Limits Cooling	60
10.2.3	Compressor Hysterezis/Offset Cooling.....	61
10.2.4	Dew Point Control	61
10.2.5	Dew Point Control Enable/Disable (OEM)	62
10.2.6	Passive Cooling	62
10.2.7	Passive Cooling Info	63
10.2.8	Brine Temperature Control	64
10.3	Room Terminals.....	65
10.3.1	pAD Status.....	66
10.3.2	pAD Scheduler.....	66
10.3.3	pAD Display Config.....	68
10.3.4	pAD Key Config	69
10.3.5	pAD Configuration.....	70
10.3.6	pAD HW Setup/Info.....	71
10.3.7	pAD Debug	72
10.3.8	pADxx Alarms	73
10.3.9	pAD related supervisor parameters	74
10.4	Configuration.....	75
10.4.1	75
10.4.2	Timing	75
10.4.3	Double compressor unit setup	76
10.4.4	Pump Timing.....	76
10.4.5	Remote On/Off (Tariff) configuration	77
10.4.6	SHW/H&C timing	77
10.4.7	Compressor 1 Statistics.....	77
10.4.8	Compressor 2 Statistics.....	78
10.4.9	Service Time / Fan Time.....	78
10.4.10	Pump Time.....	79
10.4.11	Heater Statistics.....	79
10.4.12	Heat Pump ID / SW Release	80
10.4.13	Probes Selection.....	80
10.4.14	ID Configuration 1	81
10.4.15	ID Configuration 2	81
10.4.16	ID Configuration 3	81
10.4.17	Relay Configuration 1	82
10.4.18	Relay Configuration 2	82
10.4.19	Relay Configuration 3	83
10.4.20	Relay Configuration 4	83
10.4.21	Analog Output Configuration	84
10.5	Pump Set	85
10.5.1	Pump Timing.....	85
10.5.2	Pump Speed Heating.....	85



10.5.3	Pump dT Mode (Reserved for future use)	86
10.5.4	Pump Speed Cooling	86
10.5.5	Pump Antifreeze Function	86
10.5.6	Pump Flow Alarm.....	86
10.5.7	Pump HW config.....	87
10.6	Fan (Brine Pump) Set	87
10.6.1	Fan Timing	87
10.6.2	Fan Speed Heating Mode	88
10.6.3	Fan Speed Cooling Mode	89
10.6.4	Fan On/Off Cooling Mode	90
10.6.5	Fan PID setting Cooling Mode	90
10.6.6	Fan - Winter Periodic Run	91
10.6.7	Fan I/O Configuration.....	91
10.7	Alarms Set	92
10.7.1	Antifreeze Alarm	92
10.7.2	Low Pressure Alarm.....	93
10.7.3	High Pressure Alarm.....	93
10.7.4	Low Evaporating Temperature	94
10.7.5	High Condensing Temperature.....	94
10.7.6	High Compressor Discharge Temperature	95
10.7.7	Flow Switch Delay.....	95
10.7.8	Alarm Relay Type	95
10.8	Defrost Set	96
10.8.1	Defrost Point A.....	96
10.8.2	Defrost Point B.....	97
10.8.3	Forced Defrost Set.....	97
10.8.4	Defrost Limit, End, Heater activation Temperature	98
10.8.5	Defrost Timing 1.....	98
10.8.6	Defrost Timing 2.....	99
10.8.7	Hot Water at Defrost	100
10.8.8	Defrost Info	100
10.8.9	Defrost Factory Setting	101
10.9	EExpansion Set	102
10.9.1	Eexpansion info	102
10.9.2	Config.....	103
10.9.3	Evaporating Reference	103
10.9.4	Condensing Reference	104
10.9.5	EEV Steps.....	105
10.9.6	EEV Capacity.....	106
10.9.7	EEV Control Type	106
10.9.8	DGT Temperature Setting	108
10.9.9	DGT Configuration	109
10.9.10	DGT PID Setting	109
10.9.11	DGT Timing.....	110
10.9.12	S/DGT Setting.....	111
10.9.13	SGT Superheat, MOP.....	111
10.9.14	SGT LOP	112
10.9.15	SGT Superheat Low	112
10.9.16	SGT EVD Setting	113
10.9.17	Expansion Info DGT.....	114
10.9.18	Expansion Info SDGT	115
10.9.19	EExpansion Set EVI - 1.part	115
10.9.20	EExpansion Set EVI - 2.part	117
10.9.21	EEV Default Setting	117
10.10	Speed Set	118
10.10.1	Speed Info.....	118
10.10.2	Speed Setting Heating.....	118
10.10.3	Speed Setting Cooling	119
10.10.4	Speed Setting Offset.....	120
10.10.5	Speed Setting PID	120
10.10.6	Speed Setting Defrost.....	121
10.10.7	Speed Defrost PID	121
10.10.8	Speed Setting Config.....	122
10.10.9	Speed Setting Limits.....	122



10.10.10	Speed Compressor Map	123
10.10.11	Speed Setting – CrankCase Heater	123
10.10.12	Speed Drive Status (Info).....	124
10.10.13	DC drive – Alarms table:	125
10.10.14	Speed Drive Setting (entrance to DC drive menu)	126
10.10.15	Speed Brine Control.....	126
10.11	Evd Evolution	127
10.12	Protocols Set.....	128
10.12.1	Ports Information.....	128
10.12.2	BMS Configuration	128
10.12.3	BMS2 Configuration.....	129
10.12.4	FieldBus Configuration.....	130
10.12.5	FieldBus 2 Configuration	130
10.12.6	pLAN Configuration.....	131
10.12.7	Modbus Master Configuration.....	132
10.12.8	Modbus Master 1st Configuration.....	132
10.12.9	Modbus Master 2nd Configuration.....	133
10.12.10	Carel Master Configuration	133
10.13	I/O Configuration.....	134
10.13.1	B1 to B3 Probes.....	134
10.13.2	B4 to B5 Probes.....	135
10.13.3	ID1 to ID8 Digital Inputs	135
10.13.4	Analog Outputs AO1 to AO4.....	136
10.13.5	DO1 to DO8 Digital Outputs	138
10.13.6	pCOe Configuration	138
10.13.7	pCOe Limits B1 to B4 (analog input)	139
10.13.8	pCOe Offset.....	139
10.13.9	pCOe Offline Setting.....	139
10.13.10	pCOe ID1 to ID4 Digital Inputs	140
10.13.11	pCOe DO1 to DO4 Digital Outputs	140
10.13.12	I/O Config pCOe - Parameters	141
10.14	Heat/Cool Circuits.....	142
10.14.1	Heat/Cool Circuits – Main Menu	142
10.14.2	Heat/Cool Circuits – HC1 (HCx) Heating Setting	143
10.14.3	Heat/Cool Circuits – HC1 (HCx) Cooling Setting.....	144
10.14.4	Heat/Cool Circuits – HC1 (HCx) Compensation Setting.....	145
10.14.5	Heat/Cool Circuits – HC1 (HCx) Setting operating range.....	146
10.14.6	Heat/Cool Circuits – HC1 (HCx) Function Setting	147
10.14.7	Heat/Cool Circuits – HC1 (HCx) PID setting	147
10.14.8	Heat/Cool Circuits – HC1 (HCx) Analog output.....	148
10.14.9	Heat/Cool Circuits – HC1 (HCx) Run Setting	149
10.14.10	Heat/Cool Circuits – HC1 (HCx) Group management	149
10.14.11	Heat/Cool Circuits – HC1 (HCx) HW setting (I/O)	150
10.14.12	Heat/Cool Circuits – HC1 (HCx) Alarm Output.....	151
10.14.13	Heat/Cool Circuits – HC1 (HCx) Name.....	151
10.14.14	Heat/Cool Circuits – HC1 (HCx) – Probe Alarm	152
10.14.15	Heat/Cool Circuits – HC1 (HCx) – DewPoint Protection	152
10.15	Heat/Cool Circuits – Summary table.....	153
10.16	Heat/Cool Circuits – SOLAR.....	155
10.16.1	Heat/Cool Circuits – Solar Main Setup	156
10.16.2	Heat/Cool Circuits – Solar Main Setup - Pump	157
10.16.3	Heat/Cool Circuits – Solar Main Setup - Probes	158
10.16.4	Heat/Cool Circuits – Solar Main Setup - Relay.....	158
10.16.5	Heat/Cool Circuits – Solar Main Setup - info Alarm.....	160
10.17	Heat/Cool Circuits – Pool.....	161
10.17.1	Heat/Cool Circuits – Pool Main Setup	161
10.17.2	Heat/Cool Circuits – Pool Main Setup / Offset, Time.....	162
10.17.3	Heat/Cool Circuits – Pool Filtration Timer.....	163
10.17.4	Heat/Cool Circuits – Pool Main Setup / Inputs, priority.....	164
10.17.5	Heat/Cool Circuits – Pool Main Setup / Relays	165
10.17.6	Heat/Cool Circuits – Pool Main Setup / Relays manual	165
10.17.7	Heat/Cool Circuits – Pool Main Setup / Alarm.....	166
10.18	Heat/Cool Circuits – High Temp.Protection (HTP)	166
10.18.1	Heat/Cool Circuits – HTP Setting	167



10.19	Heat/Cool Circuits – Universal Thermostat 1 to 3	168
10.19.1	Heat/Cool Circuits – UT1 (UT2, 3) Setting.....	169
10.19.2	Heat/Cool Circuits – Differential Tstat 4.....	170
10.19.3	Heat/Cool Circuits – UT4 Setting.....	171
10.20	Sanitary Hot Water.....	172
10.20.1	SHW Configuration	172
10.20.2	Hot Water Timing.....	173
10.20.3	SHW HW Configuration	173
10.20.4	Antilegionella Function.....	174
10.20.5	Solar Period	175

1 Introduction

The pCO⁵ electronic controller with the PGD visual display unit is a programmable controller, enabling to control heat pumps.

The product range of heat pumps delivered by Master Therm CZ includes the controllers integrated in AIRMASTER, EASYMASTER, BOXAIR air/water heat pumps and AQUAMASTER water/water heat pumps.

2 Visual display unit

The communication with the regulator is made possible by the visual display unit with graphic display, keyboard, and indicators. It is possible to use the keyboard to take basic control of the heat pump such as:

- Setting the mode of operation
- Solving emergency states
- Checking the state of the heat pump (indication of operation, operating temperature)

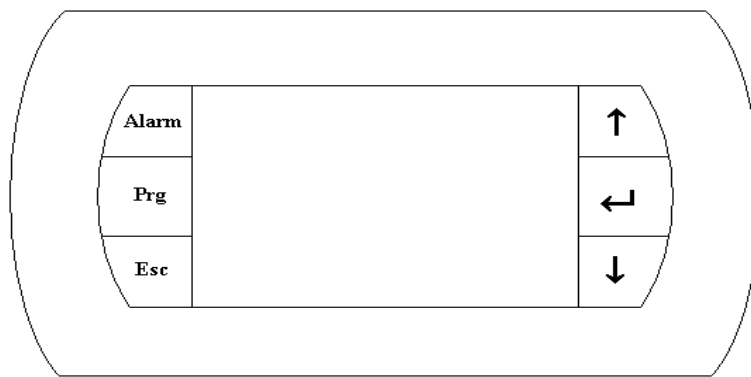

2.1 Display unit

It is the graphic display unit with the resolution of 132x64 pixels. The unit displays operating and configuration parameters.

2.2 Denotation and functions of keyboard keys and backlighting

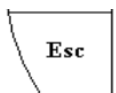

ESC key

- Is used for escaping from a menu or for jumping one level higher in the menu
- Backlighting indicates that the device is under voltage.

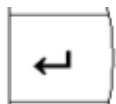

ENT key

- Is used for saving entered parameters and for jumping to another variable indicated on the screen
- Backlighting indicates that the device is under voltage.



ALARM key

- A short press is designed for entering the alarm displayed
- If backlighting flashes on and off, an alarm is active
- If backlighting is lit steadily, the manual alarm reset is necessary (the same error 3x per hour).

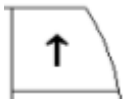

UP key

Moves the cursor up, lists in the menu, increments the parameter value
 - It starts the manual defrosting along with the DOWN key.

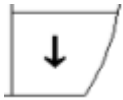

DOWN key

- Moves the cursor down, lists in the menu, decrements the parameter value
 - It starts the manual defrosting along with the UP key.

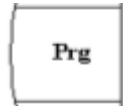

PRG key

- Is used for entering the detailed menu of the controller from the initial display
 - Is used for entering the menu to set up heating circuits (optional)
 - calls in Help in some screens.

2.3 Language Change

Pressing keys ESC and ENTER simultaneously will change to the next available language.

3 Structure of the menu

3.1 Main screen

This screen is automatically activated after turning the main switch on. The main screen is also automatically activated after escaping from the detail menu of the control unit (ESC key). The main screen indicates the operating condition of the unit. The following icons are displayed in the main screen:

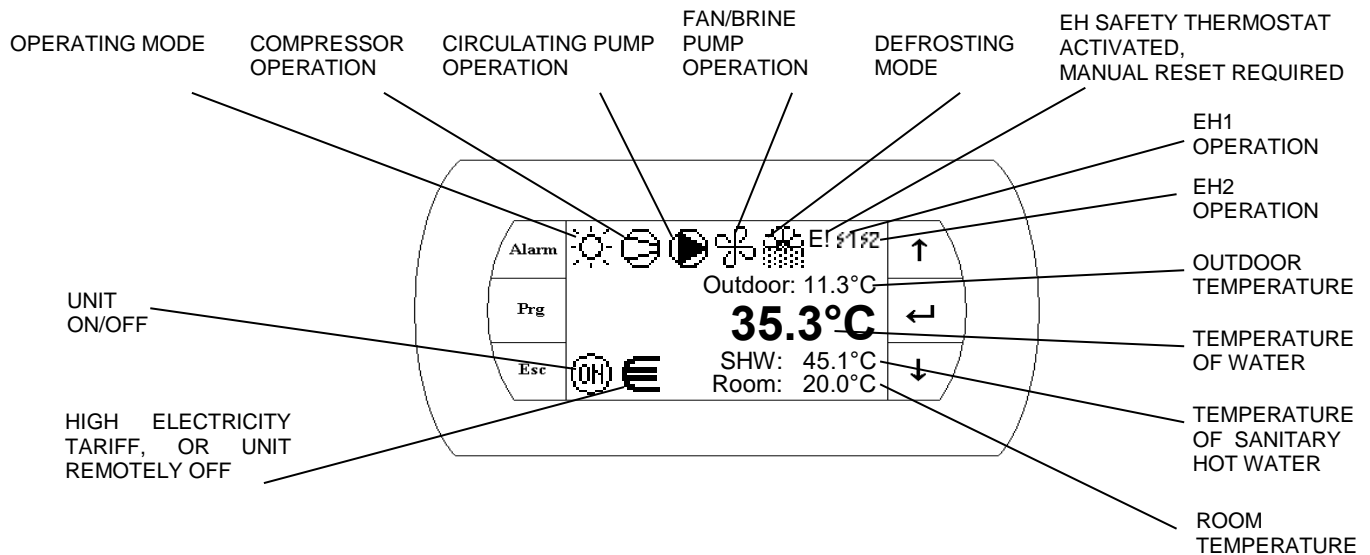

3.1.1 Operating Mode

Following operating modes are possible:

- Heating
- Heating – low outdoor temperature (aux. heaters only, compressor OFF)
- Cooling, or Passive Cooling (GSHP only)
- Cooling with Dew Point protection (no humidity condensation possible)

 Sanitary Hot Water preparation active

 Swimming Pool heating active

—When icon is FLASHING, unit is in the SUMMER MODE.

3.1.2 Compressor Operation

Following compressor indicators are possible:

 Compressor no. 1 in operation

 Compressor no. 2 in operation (2 compressor units only)

 Compressors 1 and 2 in operation (2 compressor units only)

 Recommended Unit Service Inspection

This situation is NOT ALARM and unit continues in normal operation.

After typical compressor time in operation, it is recommended refrigerant circuit service inspection. Typical time is 3000 operating hours, therefore we recommend service inspection in 6 months from service icon appearing.

3.1.3 Pump Operation

Following circulating pump indicators are possible:

 Heating Circulating Pump in operation

—When icon is flashing more than 10s after the circulating pump start, the flow did not start and pump was switched off to protect it from damaging. This situation is called “Pump Alarm”. System tries to restart the pump each compressor off time. This situation is usually connected to “Flow Alarm”, please see the “Alarms” chapter.

3.1.4 Fan/Brine Pump Operation

Following Fan (Air to Water), or Brine Pump (GSHP) indicators are possible

 Fan/Brine Pump in operation

3.1.5 Defrost Mode

Defrost status indication for Air/Water heat pumps.

—Flashing Icon indicates Temperature Condition for Defrost Mode, but minimum time from last defrost cycle has not elapsed

—Permanent Icon indicates Active Defrost Mode.

**During Defrost Mode “Steam/Fog” can appear in the area of outdoor unit.
This is standard behaviour.**

3.1.6 Electric Heater Operation and Safety Thermostat Activated

When the Electric (Auxiliary) Heater Safety Thermostat is activated the icon “E!” will appear on the main screen.

This situation could happen by the overheating of the electric heater, caused by insufficient water pressure in the heating system, or by heating circulation pump malfunction. This problem is also related “FLOW” Alarm.

When this situation occurs, it is necessary to manually reset the Safety Thermostat. Please see the “Troubleshooting” chapter for Safety Thermostat location and reset procedure.

 Heater no 1 in operation

 Heater no 2 in operation

When Icons are **FLASHING**, the system is requesting heater operation, but due to Safety Thermostat activation or “Pump Alarm” heater could not be started. Please reset the Safety Thermostat or fill the water to the heating system.

3.1.7 Outdoor Temperature

The real outdoor temperature is shown on the display in °C.

3.1.8 Temperature of Water

Actual heating water temperature is shown on the display in °C.

3.1.9 Sanitary Hot Water Temperature

When the Heat Pump is configured for preparing of Sanitary Hot Water, the display is showing actual Sanitary Hot Water temperature.

3.1.10 Room Temperature

When the Room Temperature Probe is used, it is shown on the main display.

When Room Terminal (pAD) is used, the temperature is not shown on the main display. In case pAD Room Terminal or, more pADs are used, please see the pAD menu (list using arrow down).

3.1.11 Electricity Tariff / Remote Off

Following situations are possible:

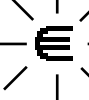
-  High Electricity Tariff is active (where applicable), or unit is Remotely OFF
-  Flashing symbol indicates High Electricity Tariff or Remote OFF, but Compressor operation is configured to ignore the command.

3.1.12 Unit On/Off

Following operators are possible:

 Unit is ON

 Unit is OFF

3.2 Auxiliary screens

Auxiliary screens can be displayed by pressing the UP or DOWN keys. After the last screen has been displayed, the main screen with icons will be automatically reached when the UP or DOWN keys are pressed.

By pressing the ESC key in any of the auxiliary screens, the main screen with icons will be automatically reached.

Pressing PRG key will cause entering “deeper” menu, enabling more detailed setting.

3.2.1 Setting Unit Operation

This screen indicates the ON/OFF state, HEATING/COOLING function and AUTO/SUMMER/WINTER mode. This screen enables to change the operating mode of the heat pump.

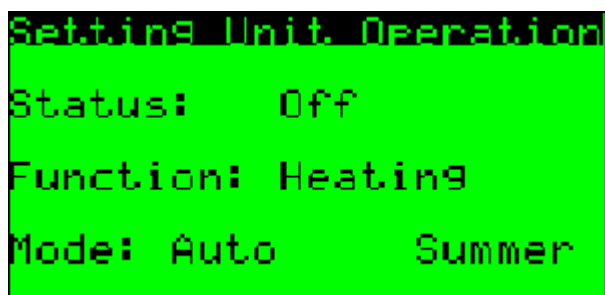

By pressing the ENT key, the cursor moves to a variable that can then be edited with UP and DOWN keys – to change its value. After you have entered a desirable value, it is necessary to confirm it by pressing the ENT key, making the cursor move to another variable. After the last variable on the screen has been edited, the cursor returns to the top left corner of the screen. After that you can use the UP or DOWN keys to move to previous or next screens.

In this case, the unit can be switched from ON to OFF and vice versa, it is possible to change the function of the heat pump into HEATING or COOLING and change the operating mode to AUTO, WINTER, OR SUMMER. The function HEATING/COOLING can only be changed if the state "Status = OFF".

Parameters Setting:

Parameter:	Range:	Unit	Description
Status	On Off	-	On: unit is ON. Off: unit is OFF.
Function	Auto Heating Cooling*	-	Auto: Function is automatically selected according to the Mode setting. Heating: All heating circuits are in operation. Cooling: All cooling circuits are in operation. Heating is disabled with exception of the Sanitary Hot Water and Swimming Pool. Mode is forced to Summer.
Mode	Auto Winter Summer	-	Auto: Mode is automatically selected according to the outdoor temperature. Winter: All heating circuits are in operation. Cooling is disabled. Summer: Heating is disabled with exception of the Sanitary Hot Water and Swimming Pool.

* Cooling is available only for Reversible Heat Pump or GSHP with Passive Cooling Module.

3.2.1.1 Setting Automatic Changeover

Pressing PRG key from previous screen displays mask with automatic changeover.

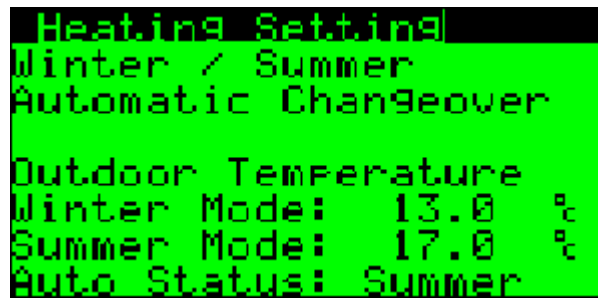

Parameters Setting:

Parameter:	Range/F.:	Unit	Description
Winter Mode	-20.0 40.0 F:+13.0	°C	Outdoor temperature for activation of Winter Mode. Below this temperature, Winter Mode is activated.
Summer Mode	-20.0 40.0 F:+17.0	°C	Outdoor temperature for activation of Summer Mode. Above this temperature, Summer Mode is activated.
Auto Status	Winter Summer	-	Result of the Automatic Changeover according to the setting above.

Note: The mode is not changed according to actual outdoor temperature, but rather the “average” outdoor temperature, created inside the controller.

Pressing ESC key, the previous “Setting Unit Operation” screen is displayed.

3.2.2 Sanitary Hot Water

The next auxiliary screen is the Sanitary Hot Water (SHW) main display. This screen is available, when heat pump is configured to prepare SHW.

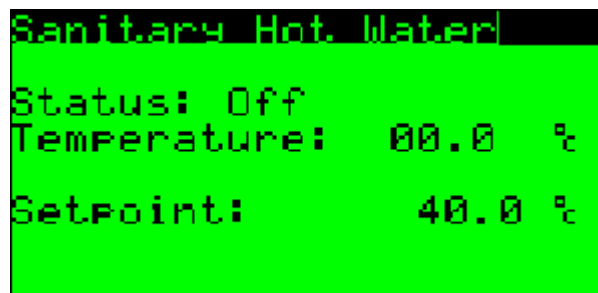

Parameter:	Range/F.:	Unit	Description
Status	On Off	-	On: SHW function is activated. Off: SHW function is not activated.
Temperature	-	°C	Actual SHW temperature..
Setpoint	0 45(60*)	°C	Requested SHW temperature set by user.

* When setpoint is higher than 45°C, it is possible, the electric heater will be activated to reach the requested temperature.

3.2.2.1 Antibacteria (Legionella) Function

Using PRG from previous screen, the Antilegionella setting screen is shown. Legionella is bacteria, generally present in tap cold water in small quantity. Small quantity is not dangerous for humans. When tap water temperature is in range between 25°C to 35°C, the Legionella bacteria is reproducing exponentially. When this temperature range is maintained for long period of time, the quantity of bacteria in some cases could reach level dangerous for humans in case of inhalation. This could happen an example during showering. Legionella could cause disease similar to pneumonia. Although the risk for healthy human is very low, it is dangerous for humans with decreased immunity.

From reasons listed above, we recommend to keep the SHW setpoint around 45°C (not lower than 40°C), when bacterial growth is 0 or very low.

Anyway it is possible to enable “Antilegionella” function. When function is enabled, the SHW setpoint is weekly automatically increased and maintained for programmed period of time. Sufficient is the temperature 60°C, that kills all Legionella bacteria present in the water in a few minutes.

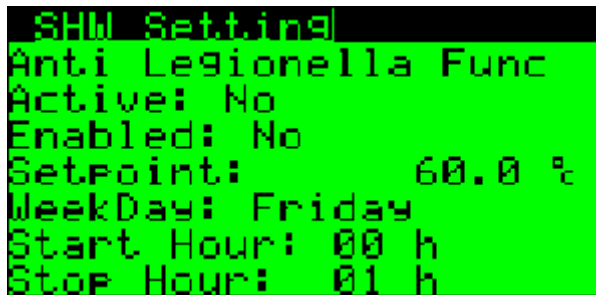

```

SHW Settings
Anti Legionella Func
Active: No
Enabled: No
Setpoint: 60.0 °C
WeekDay: Friday
Start Hour: 00 h
Stop Hour: 01 h
  
```

Parameter:	Range/F.:	Unit	Description
Active	No Yes	-	Showing the antibacterial function is actually in operation.
Enabled	No Yes F: No	-	Enabling the function. No: Function is not enabled. Yes: Function is enabled.
Setpoint	0 65*	°C	Requested SHW temperature set for Antilegionella function by user.
WeekDay	Mo-Su F: Friday	-	Day of the week for function activation.
Start Hour	0-23 F: 0	h	Start hour of the increased SHW setpoint.
Stop Hour	0-23 F: 2	h	Stop hour of the increased SHW setpoint. We recommend 1 hour of time for each 100 l of the SHW tank volume. Example: SHW tank volume is up to 200 l . We recommend 2 hour period. SHW tank volume is 300 l . We recommend 3 hour period.

* Cause the setpoint is higher than 45°C, it is possible, the electric heater will be activated to reach the requested temperature.

Note: For correct function, the heat pump must be equipped with internal or external electric heater or gas boiler.

Using ESC key returns to the Main SHW display. Using UP/DOWN keys lists in SHW menu.

3.2.2.2 Solar Period function

Function to block SHW preparation by the heat pump according to simple timer setting.

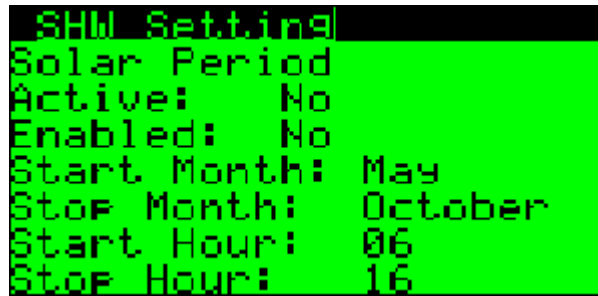

Parameter:	Range/F.:	Unit	Description
Active	Yes No	-	Yes: unit is in Solar Period No: unit is in normal mode
Enabled	Yes No	-	Yes: function is enabled No: function is disabled
Start Month	Jan-Dec	-	Month to start function
Stop Month	Jan-Dec	-	Month to stop function
Start Hour	00-23	h	Hour of the day to start function
Stop Hour	00-23	h	Hour of the day to stop function

Simply set the timer to block SHW preparation to allow solar thermal energy heat up the SHW.

Using ESC key returns to the Main SHW display. Using UP/DOWN keys lists in SHW menu.

3.2.3 Heating/Cooling

This display informs about the main heat pump heating/cooling circuit status and enables the Automatic or Manual circuit operation.

```

Heating/Cooling
Room Temperature
Requested:      20.00 °C
Actual:        00.0 °C
Water Temperature
Requested: 00.0 / 00.0 °C
Actual:       36.0 °C
Mode: Auto    00.0
  
```

Parameter:	Range/F.:	Unit	Description
Room Temperature Requested	6.0 32.0 F: 20.0	°C	Requested Room temperature set by user. When Room probe is not used, this value is considered to adjust the water temperature. When pAD room terminal is used, entered value is automatically transferred to the pAD and vice versa.
Room Temperature Actual	-99.9 99.9	°C	If room temperature probe is used or pAD room terminal is used, this value is showing the real room temperature (Main Zone)
Water Temperature Requested	-99.9 99.9	°C	xx.x: The first value is the requested temperature according to the weather compensation setting of the main heating/cooling circuit. /xx.x: The second value is the result of all requests from the other heating/cooling circuits and exactly the real requested setpoint for Heat Pump.
Water Temperature Actual	-99.9 99.9	°C	Actual heating/cooling water temperature.
Mode	Auto Manual F: Auto	-	Auto: Automatic operation according to the setting of the main weather compensation curve. Manual: Manual operation according to entered value.
Manual Requested Temperature	*-99.9 99.9	°C	Requested heating/cooling water temperature set by user.

* The real temperature range is limited according to the setting during commissioning.

3.2.3.1 Heating Setting

Pressing PRG from previous screen will show Main Heating Weather Compensation Setting display.

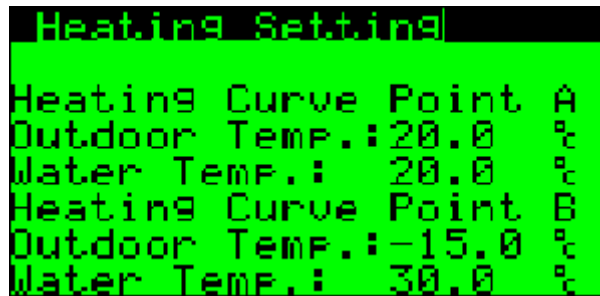

Weather compensation parameters could be shown on following picture:

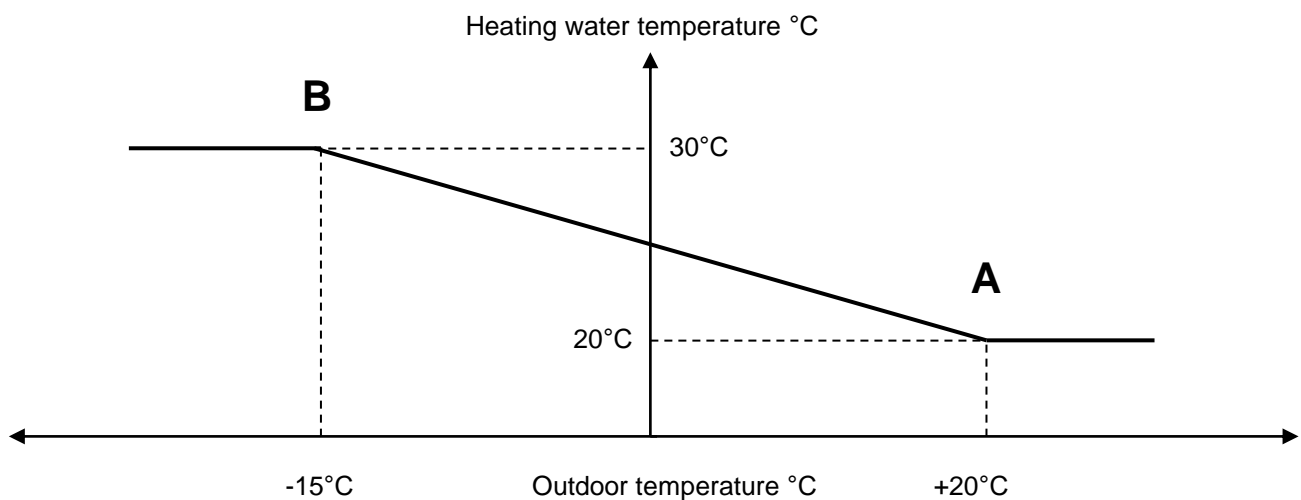

Parameter:	Range/F.:	Unit	Description
Point A Outdoor Temperature	-20.0 30.0 F: 20.0	°C	Point A, outdoor temperature definition.
Point A Water Temperature	*20.0 47.5 F: 20.0	°C	Point A, water temperature definition. Requested heating water temperature for defined Point A outdoor temperature. 20.0°C is typical setting for Under Floor Heating (UFH) and Radiators.
Point B Outdoor Temperature	-20.0 30.0 F: -15.0	°C	Point B, outdoor temperature definition.
Point B Water Temperature	*20.0 47.5 F: 30.0	°C	Point B, water temperature definition. Requested heating water temperature for defined Point B outdoor temperature. 30.0°C is typical setting for UFH. 40.0°C is typical setting for Radiators.

* The real temperature range is limited according to the setting during commissioning.

Use ESC key for return to previous display.

Use UP or DOWN key to reach the "Cooling Setting", for units with Cooling, or Passive Cooling only.

3.2.3.2 Cooling Setting

This display is available only for units with Cooling, or Passive Cooling (Optional Equipment). Display enables setting of the Main Cooling Weather Compensation.

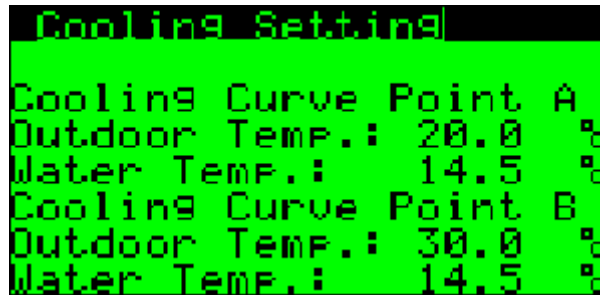

Weather compensation parameters could be shown on following picture:

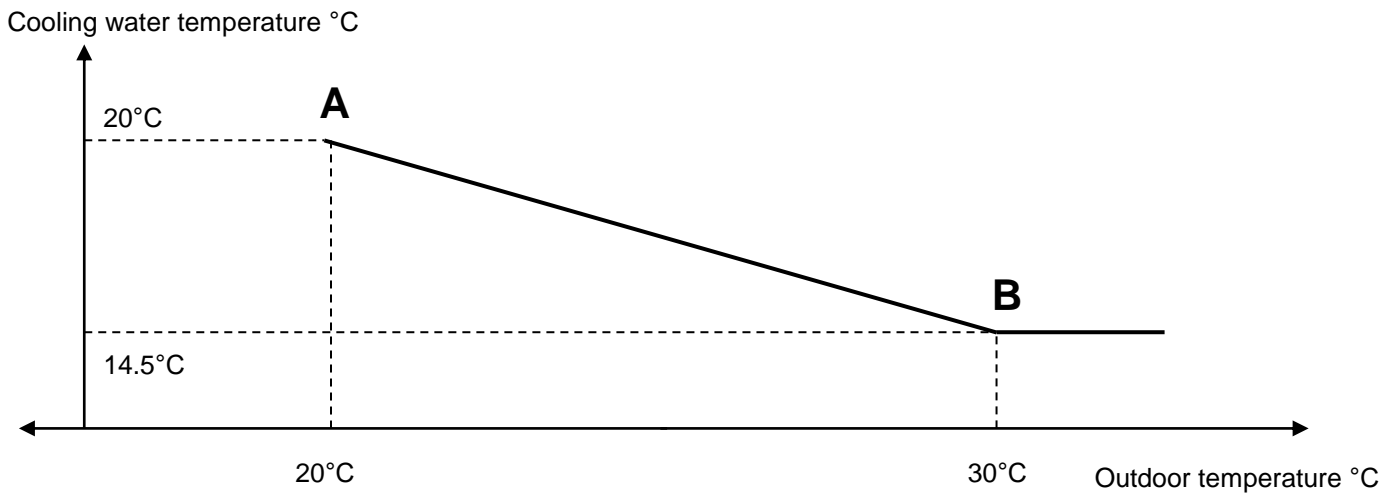

Parameter:	Range/F.:	Unit	Description
Point A Outdoor Temperature	10.0 40.0 F: 20.0	°C	Point A, outdoor temperature definition.
Point A Water Temperature	*14.5 30.0 F: 14.5	°C	Point A, water temperature definition. Requested cooling water temperature for defined Point A outdoor temperature. 20.0°C is typical setting for Under Floor Heating (UFH) and FanCoils.
Point B Outdoor Temperature	10.0 40.0 F: 30.0	°C	Point B, outdoor temperature definition.
Point B Water Temperature	*14.5 30.0 F: 14.5	°C	Point B, water temperature definition. Requested cooling water temperature for defined Point B outdoor temperature. 18.0°C is typical setting for UFH. 14.5°C is typical setting for FanCoils.

* The real temperature range is limited according to the setting during commissioning. Additional limitation is possible due to the Dew Point protection if it is activated.

Use ESC key for return to the display Heating/Cooling.

3.2.4 Room Terminal pADxx

When pAD room terminal is installed, following display automatically appears in the menu.

```

pAD 01 Room Terminal
On/Off: PERMANENT OFF
Mode:   None
Setpoint:      00.0°C
Temperature:   00.0°C
Rel.Humidity:  000 %
  
```

Parameter could be adjusted directly on pAD room terminal or remotely on pGD display using this mask.

Parameter:	Range/F.:	Unit	Description
pAD	01, 11-16	-	pAD Identification Number. This Parameter is not adjustable. It is given by pAD Hardware Address. 01: Main Zone Room Terminal 11: Heating Circuit 1 Room Terminal 12: Heating Circuit 2 Room Terminal 13: Heating Circuit 3 Room Terminal 14: Heating Circuit 4 Room Terminal 15: Heating Circuit 5 Room Terminal 16: Heating Circuit 6 Room Terminal
On/Off	Permanent OFF OFF ON	-	Permanent OFF: Terminal is permanently OFF and heating/cooling of the zone is disabled. OFF: Terminal is OFF by the scheduler and heating/cooling of the zone is temporarily disabled. ON: Terminal is ON and heating/cooling of the zone is enabled.
Mode	Winter Summer	-	For pAD 01 it has the same meaning like the main Mode of the Heat Pump. When unit is equipped with cooling or passive cooling, with Mode change also Function is changed. For pAD11 to 16, the Mode setting has no effect and Mode is forced according to the Heat Pump Mode. Heat Pump has priority to pAD11 to 16.
Setpoint	6.0 to 32.0	°C	Requested Room Temperature set by user.
Temperature	-99.9 to 99.9	°C	Real Room Temperature
Rel. Humidity	0-100	%	Real Room Relative Humidity

Note: Terminal **pAD 01** – Main Room Terminal has absolute priority if it is installed.

Using PRG key enters detailed pAD setting menu.

3.2.4.1 pADxx Status

This mask is accessible pressing PRG key from the pADxx display.

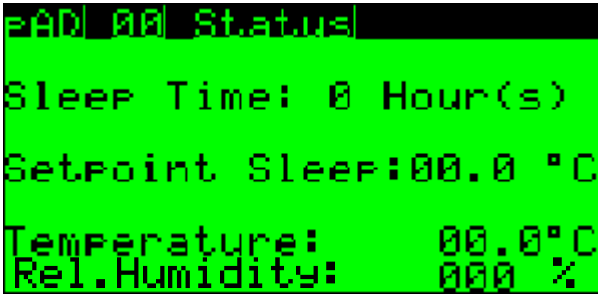

```

pAD 00 Status
Sleep Time: 0 Hour(s)
Setpoint Sleep: 00.0 °C
Temperature: 00.0°C
Rel. Humidity: 000 %
  
```

Parameter:	Range/F.:	Unit	Description
pAD	01, 11-16	-	pAD Identification Number. This Parameter is not adjustable. It is given by pAD Hardware Address. 01: Main Zone Room Terminal 11: Heating Circuit 1 Room Terminal 12: Heating Circuit 2 Room Terminal 13: Heating Circuit 3 Room Terminal 14: Heating Circuit 4 Room Terminal 15: Heating Circuit 5 Room Terminal 16: Heating Circuit 6 Room Terminal
Sleep Time	0-9	h	Remaining time of the pAD Sleep Function.
Setpoint Sleep	6.0 – 32.0	°C	Room Temperature Setpoint for pAD Sleep Function. Temporary Room Setpoint for the Sleep Time set. When Sleep Time elapses, Setpoint is returned to standart value set on the pAD.
Temperature	-99.9 to 99.9	°C	Real Room Temperature
Rel. Humidity	0-100	%	Real Room Relative Humidity

ESC key returns to pADxx Room Terminal display.
Using UP/DOWN keys lists in the pAD menu.

3.2.4.2 pADxx Scheduler

Scheduler setting consists of 2 displays.

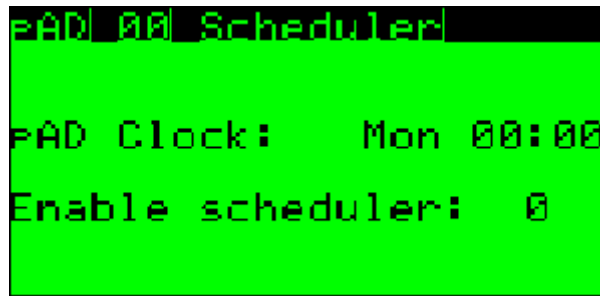

Parameter:	Range/F.:	Unit	Description
pAD	01, 11-16	-	pAD Identification Number. This Parameter is not adjustable. It is given by pAD Hardware Address. 01: Main Zone Room Terminal 11: Heating Circuit 1 Room Terminal 12: Heating Circuit 2 Room Terminal 13: Heating Circuit 3 Room Terminal 14: Heating Circuit 4 Room Terminal 15: Heating Circuit 5 Room Terminal 16: Heating Circuit 6 Room Terminal
pAD Clock	Mo-Su 00:00-23:59	d h:m	pAD actual time. Time is automatically synchronized with the main controller.
Enable Scheduler	0 1	-	0: Scheduler is not enabled. 1: Scheduler is enabled.
Mon-Fri time 1 2	00:00-23:59 00:00-23:59	h:m h:m	Start time of the first time zone for Monday to Friday. Start time of the second time zone for Mo to Fr.
Mon-Fri set 1 2	Off/6.0-32.0/On Off/6.0-32.0/On	°C/- °C/-	Room Setpoint, or simple On/Off request for TZ 1. Room Setpoint, or simple On/Off request for TZ 2.
Sat-Sun time 1 2	00:00-23:59 00:00-23:59	h:m h:m	Start time of the first time zone for Sat - Sun. Start time of the second time zone for Sat - Sun.
Sat-Sun set 1 2	Off/6.0-32.0/On Off/6.0-32.0/On	°C/- °C/-	Room Setpoint, or simple On/Off request for TZ 1. Room Setpoint, or simple On/Off request for TZ 2.

ESC key returns to pADxx Room Terminal display.
Using UP/DOWN keys lists in the pAD menu.

3.2.4.3 pADxx Alarms

If pAD is in Alarm Status it is possible to see it on this display.

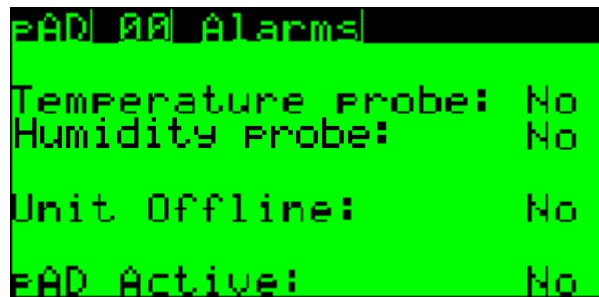

Parameter:	Range/F.:	Unit	Description
pAD	01, 11-16	-	pAD Identification Number. This Parameter is not adjustable. It is given by pAD Hardware Address. 01: Main Zone Room Terminal 11: Heating Circuit 1 Room Terminal 12: Heating Circuit 2 Room Terminal 13: Heating Circuit 3 Room Terminal 14: Heating Circuit 4 Room Terminal 15: Heating Circuit 5 Room Terminal 16: Heating Circuit 6 Room Terminal
Temperature Probe	No Yes	-	No: Temperature probe is not in alarm. Yes: Temperature probe has active alarm. Contact Your installation company, pAD must be replaced.
Humidity Probe	No Yes	-	No: Humidity probe is not in alarm. Yes: Humidity probe has active alarm. Contact Your installation company, pAD must be replaced.
Unit Offline	No Yes	-	No: Unit is Online, no alarm. Yes: Unit is Offline = alarm Please check proper pAD location in the plastic frame on the wall. If the position is correct, please contact installation company.

ESC key returns to pADxx Room Terminal display.

Using UP/DOWN keys lists in the pAD menu.

3.2.5 Heating Circuits

When additional Heating/Cooling Circuit or more Heating/Cooling Circuits are enabled during commissioning, following display(s) appears in the menu.

```

HCx1 ------
Status: Off
Room Temperature
Rq/Ac: 20000 /00.0 °C
Water Temperature
Rq/Ac: 00.0 /00.0 °C
Pump: Off Servo:000.0%
Mode: Auto 00.0
  
```

This display informs about the additional heating/cooling circuit status and enables the Automatic or Manual circuit operation.

Parameter:	Range/F.:	Unit	Description
HCx	1-6	-	Heating Circuit (HC) Identification
-----	alphanumerical	-	Up to 6 characters for customized HC name
Room Temperature Rq	6.0 32.0 F: 20.0	°C	Requested Room temperature set by user. When Room probe is not used, this value is considered to adjust the water temperature. When pAD room terminal is used, entered value is automatically transferred to the pAD and vice versa.
Room Temperature Ac	-99.9 99.9	°C	If room temperature probe is used or pAD room terminal is used, this value is showing the actual room temperature of the HCx Zone
Water Temperature Rq	-99.9 99.9	°C	xx.x: The first value is the requested temperature according to the weather compensation setting of the main heating/cooling circuit. /xx.x: The second value is the result of all requests from the other heating/cooling circuits and exactly the real requested setpoint for Heat Pump.
Water Temperature Ac	-99.9 99.9	°C	Actual HCx heating/cooling water temperature.
Pump	Off On	-	Off: HCx relay (pump) is not running. On: HCx relay (pump) is running.
Servo	0-100.0	%	Mixing valve position.
Mode	Auto Manual F: Auto	-	Auto: Automatic operation according to the setting of the main weather compensation curve. Manual: Manual operation according to entered value.
Manual Requested Temperature	*-99.9 99.9	°C	Requested heating/cooling water temperature set by user.

* The real temperature range is limited according to the setting during commissioning.

Key PRG opens Weather Compensation Curve setting for HCx.

3.2.5.1 HCx Heating Curve Setting

Pressing PRG from previous screen will show Main Heating Weather Compensation Setting display for Heating Circuit (HCx).

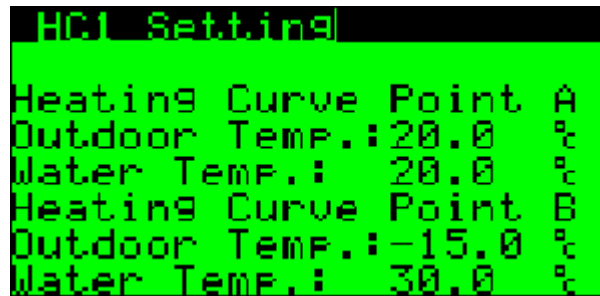

Weather compensation parameters could be shown on following picture:

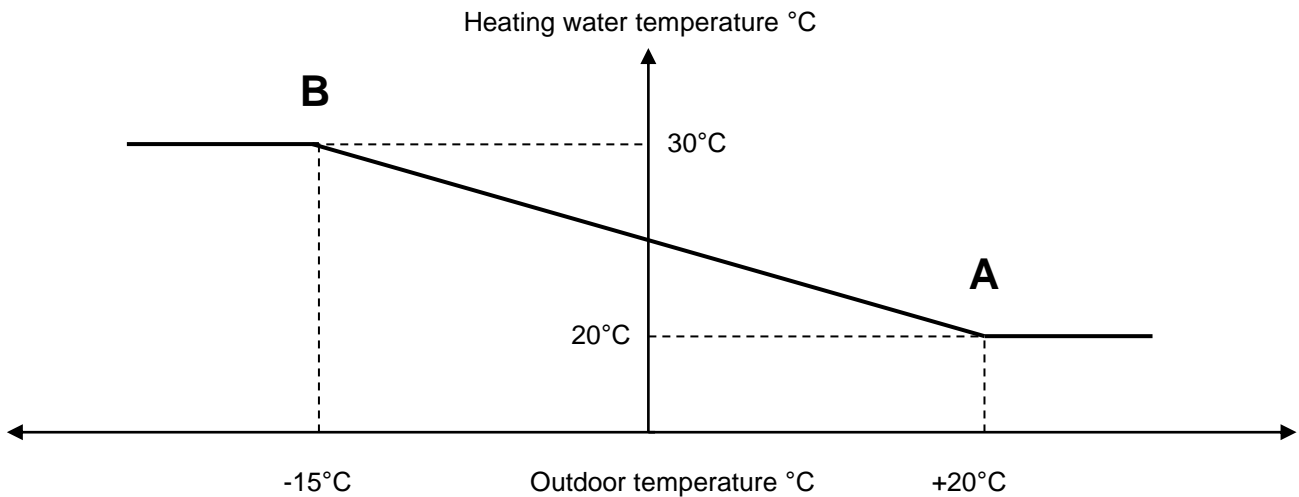

Parameter:	Range/F.:	Unit	Description
Point A Outdoor Temperature	-20.0 30.0 F: 20.0	°C	Point A, outdoor temperature definition.
Point A Water Temperature	*20.0 47.5 F: 20.0	°C	Point A, water temperature definition. Requested heating water temperature for defined Point A outdoor temperature. 20.0°C is typical setting for Under Floor Heating (UFH) and Radiators.
Point B Outdoor Temperature	-20.0 30.0 F: -15.0	°C	Point B, outdoor temperature definition.
Point B Water Temperature	*20.0 47.5 F: 30.0	°C	Point B, water temperature definition. Requested heating water temperature for defined Point B outdoor temperature. 30.0°C is typical setting for UFH. 40.0°C is typical setting for Radiators.

* The real temperature range is limited according to the setting during commissioning.

Use ESC key for return to previous display, HCx.

Use UP or DOWN key to reach the “HC1 Cooling Curve Setting”, for units with Cooling, or Passive Cooling only.

3.2.5.2 HCx Cooling Curve Setting

This display is available only for units with Cooling, or Passive Cooling (Optional Equipment). Display enables setting of the HCx Cooling Weather Compensation.

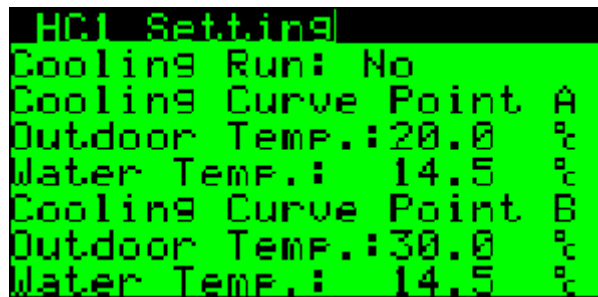

Weather compensation parameters could be shown on following picture:

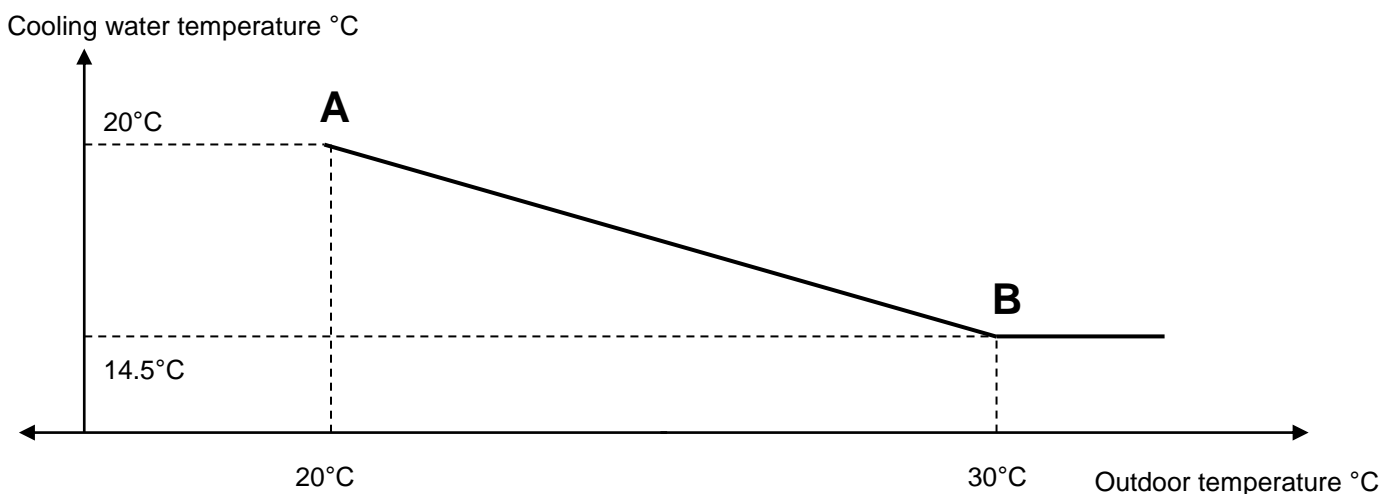

Parameter:	Range/F.:	Unit	Description
Cooling Run:	No Yes	-	No: HCx is not operating in Cooling Function. Yes: HCx is operating in Cooling Function
Point A Outdoor Temperature	10.0 40.0 F: 20.0	°C	Point A, outdoor temperature definition.
Point A Water Temperature	*14.5 30.0 F: 14.5	°C	Point A, water temperature definition. Requested cooling water temperature for defined Point A outdoor temperature. 20.0°C is typical setting for Under Floor Heating (UFH) and FanCoils.
Point B Outdoor Temperature	10.0 40.0 F: 30.0	°C	Point B, outdoor temperature definition.
Point B Water Temperature	*14.5 30.0 F: 14.5	°C	Point B, water temperature definition. Requested cooling water temperature for defined Point B outdoor temperature. 18.0°C is typical setting for UFH. 14.5°C is typical setting for FanCoils.

* The real temperature range is limited according to the setting during commissioning. Additional limitation is possible due to the Dew Point protection if it is activated.

Use ESC key for return to previous display, HCx.

3.2.5.3 HCx Custom Name

Following display enables setting of the Custom Name for Heating Circuit.



Each dash could be substituted by alphanumerical character.

Example: "1FLOOR"

This HCx "Name" appears on the main HCx mask.

3.2.5.4 Heating/Cooling Circuits (HCx) General Principle

- It is possible to enable up to 6 heating/cooling circuits
- As the heating/cooling circuits are configured during commissioning, requested setpoints with corresponding offsets are automatically transferred to the Main Heating/Cooling Circuit (Heat Pump)
- Heat Pump is always supplying highest temperature requested in the Heating Function and the lowest temperature requested in the Cooling Function, up to it's absolute limits.
- Each circuit could be equipped with pAD Room Terminal, which enables Scheduler and automatic water temperature adjusting to reach requested Room (Zone) temperature.

3.2.6 Solar

When Solar Thermal control is enabled, following display appears in the menu.

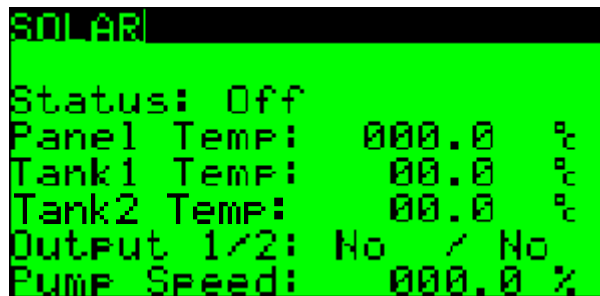

Parameter:	Range/F.:	Unit	Description
Status	Off On	-	Off: Control is disabled by the user. On: Control is enabled by the user.
Panel Temperature	-50.0 150.0	°C	Real Solar Panel temperature
Tank 1 Temperature	-50.0 99.9	°C	Real Storage Tank water temperature charged by Solar Thermal system.
Tank 2 Temperature	-50.0 99.9	°C	Real Storage Tank no.2, or additional demand side water temperature charged by Solar Thermal system. This value is shown only, when Storage Tank no.2 or additional demand side is configured (an example Swimming Pool)
Output 1/2	No, Yes	-	Relay Output no.1, or 2 status. No=Off, Yes=On
Pump Speed	0-100.0	%	Pump Speed, when Pump with variable speed is used.

3.2.7 Swimming Pool

When Swimming Pool control is enabled, following screen appears in the menu.

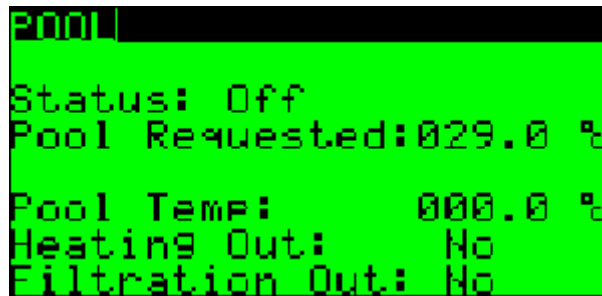

Parameter:	Range/F.:	Unit	Description
Status	Off On	-	Off: Control is disabled by the user. On: Control is enabled by the user.
Pool Requested Temperature	0.0 99.9	°C	Requested Swimming Pool water temperature set by user.
Pool Temperature	-50.0 99.9	°C	Real Swimming Pool water temperature.
Heating Out	No Yes	-	Yes: Swimming Pool heating is in operation
Filtration Out	No Yes	-	Yes: Filtration Pump in operation.

Press PRG for additional Swimming Pool setting.

3.2.7.1 Pool Filtration Timer Setting

This display enables swimming pool filtration configuration.

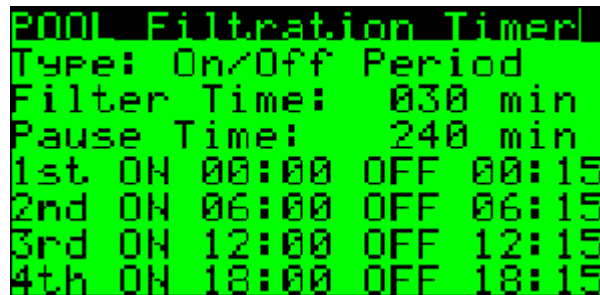

Parameter:	Range/F.:	Unit	Description
Type	On/Off Period Scheduler	-	On/Off Period: Filtration pump is activated according to the Filter/Pause Time principle. Scheduler: Filtration pumps is activated according to the Scheduler.
Filter Time	0 999	min	Filtration pump run period.
Pause Time	0 999	min	Filtration pump stop period.
1 st , 2 nd , 3 rd , 4 th ON/OFF	00:00 23:59	h:m	1st, 2nd, 3rd and 4th On/Off time scheduler definition.

Key ESC returns to the POOL mask.

3.2.8 Service Info

This is information display with refrigerant circuit operating parameters.

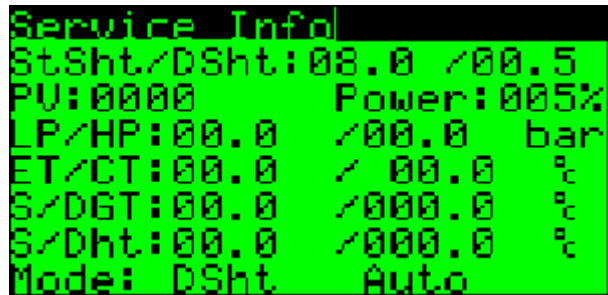

Parameter:	Range/F.:	Unit	Description
StSht	-99.9 99.9	°C	Suction Superheat Setpoint.
StDSht	-99.9 99.9	°C	Discharge Superheat Setpoint.
PV	0 9999	-	Electronic Expansion Valve Position.
Power	0 100	%	Electronic Expansion Valve capacity request.
LP/HP	-1.0 45.0	bar	Actual Compressor Suction / Discharge Pressure.
ET/CT	-50.0 99.9	°C	Actual Evaporating/Condensing Temperature.
S/DGT	-50.0 150.0	°C	Actual Suction / Discharge Gas Temperature.
S/Dht	-50.0 99.9	°C	Actual Suction / Discharge Superheat.
Mode	SSht DSht	°C	Actual Control type. SSht: Suction Superheat Control DSht: Discharge Superheat Control

3.2.8.1 Defrost Info (Air/Water units only)

Pressing PRG key on previous screen opens Defrost Info mask.

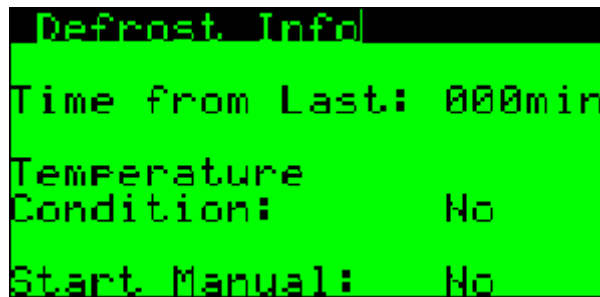

Parameter:	Range/F.:	Unit	Description
Time from Last Cycle	000 200	Min	Shows time from last defrost cycle. When period is longer than 200 minutes, the value is not increasing.
Temperature Condition	No Yes	-	Informs, if temperature condition starting the defrost cycle is met.
Start Manual	No Yes	-	When Temperature Condition is met, it is possible to manually activate the defrost cycle and bypass the minimum time between 2 defrost cycles, usually set to 45 minutes.

3.2.9 Clock

Clock screen is the Last screen of the Auxiliary Menu.

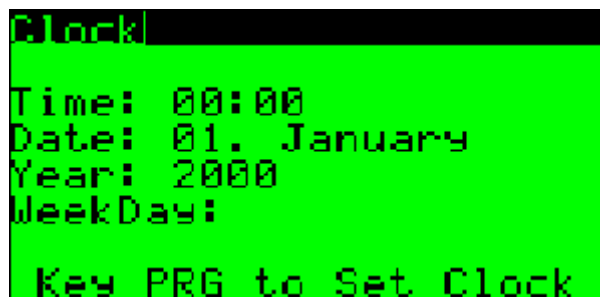

Parameter:	Range/F.:	Unit	Description
Time	00:00 23:59	h:m	Shows actual hours and minutes of the day.
Date	01. January 31. December	-	Day of the month and month.
Year	2000 2099	-	Shows actual year.
WeekDay	Monday Sunday	-	Shows day of the week.

Press PRG to set the Clock.

3.2.9.1 Setting the Clock

This display appears after pressing PRG key on previous screen.

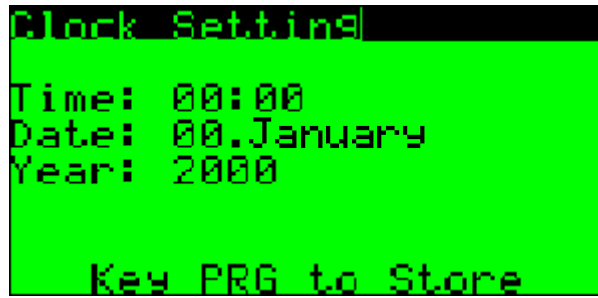

Parameter:	Range/F.:	Unit	Description
Time	00:00 23:59	h:m	Setting of the new time.
Date	01. January 31. December	-	Setting of the new day and month.
Year	2000 2099	-	Setting of the new year.

Important: After setting the new values press **PRG** key to **STORE** them, otherwise the new setting is lost.

Note: New clock setting is automatically distributed into pAD terminals.

3.2.9.2 Setting the Daylight Saving Time

This mask enables setting the automatic Daylight Saving Time (DST) changeover. Mask could be reached using UP/DOWN keys from previous screen.

```

Clock Setting
SWZ:
DST:                ENABLE
Transition time:000min
Start:--EAST ***
in ---             at 00.00
End:  --EAST ***
in ---             at 00.00
    
```

Parameter:	Range/F.:	Unit	Description
DST	Enable Disable	-	Enables or Disables automatic DST changeover.
Transition time	0 999	min	Time for changeover, when unit was not powered.
Start	First Second Third Forth Last Mon-Sun	-	Day of the Month to start the DST
At	00:00 23:59	h:m	Time to start DST
End	First Second Third Forth Last Mon-Sun	-	Day of the Month to stop DST
At	00:00 23:59	h:m	Time to stop DST

4 Alarms

Alarms may occur while the unit is in operation. The control is drawn up in such a manner that the operation can be restarted automatically. If a problem is more serious, it is necessary to reset the unit manually.

If an alarm state occurred during the operation of the unit, the backlighting of ALR key flashes on and off. If the backlighting of the key is lit steadily, the unit has been blocked and it is necessary to reset it manually.

By pressing ALARM button, the screen with active alarms, or last active alarm will be displayed.

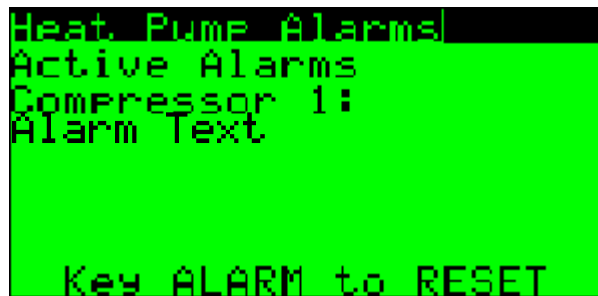

If the unit is equipped with 2 compressors, alarms are showing separately for each compressor.

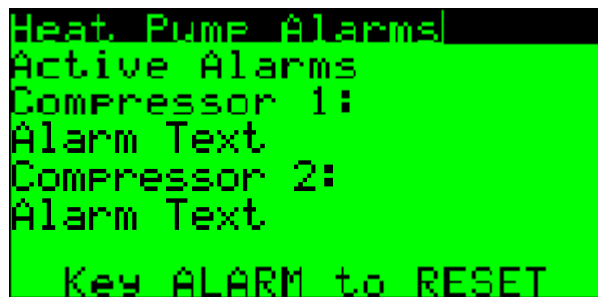

4.1 Types of alarm

Displayed Alarm Text	Alarm Code	Alarm description	Reset
Low Pressure	AL01	compressor low suction pressure	aut.<3/hrs
High Pressure PT	AL02	compressor high discharge pressure from pressure transducer	aut.<3/hrs
High Discharge Temp.	AL03	high compressor discharge gas temperature	aut.<3/hrs
High Condensing Temp.	AL04	too high refrigerant condensing temperature	aut.<3/hrs
Low Evaporating Temp.	AL05	too low evaporating temperature	aut.<3/hrs
Antifreeze	AL06	low water temperature with risk of freezing	aut.<3/hrs
Fan Thermal	AL07	fan overheating, or circuit breaker activation brine pump overheating or circuit breaker activation	aut.<3/hrs
Compressor Thermal	AL08	compressor overheating, or circuit breaker activation	aut.<3/hrs
Flow	AL09	inufficient or no flow of water thru heat pump	aut.<3/hrs
Probes	AL10	one of the important temperature sensor malfunction	automatic
High Pressure Switch	AL11	compressor high discharge pressure from pressure high pressure switch	aut.<3/hrs
Low Pressure HP side	AL12	too low pressure on high pressure side of the refrigerant circuit	aut.<3/hrs
DC Drive Alarm	AL13	alarm of the compressor drive for inverter units	automatic
EVD Evo	AL14	alarm of the Electronic Expansion Valve driver	aut.<3/hrs

4.2 General Alarm Explanation

Heat Pump is complex device consisting of sensitive components. Therefore control system switches the operation off in case the operating conditions are not suitable for unit safe and long durability operation. Operating conditions are given externally, by the actual status of power supply, actual load and operating mode request. Alarms could occur during unit standard unit operation. Until unit is not in permanent alarm, or it does not require manual reset, there is no reason to concern.

4.3 Detailed Alarm Displays

Using UP/DOWN keys lists in the alarm menu. Detailed display is available for each alarm. It shows active or inactive alarm and total alarm counter.

<pre>Heat Pump Alarms Low Pressure Active/M: Yes / Yes Alarm Counter: 00000 x High Pressure PT Active/M: Yes / Yes Alarm Counter: 00000 x</pre>	<pre>Heat Pump Alarms Flow Active/M: Yes / Yes Alarm Counter: 00000 x</pre>
<pre>Heat Pump Alarms High Discharge Temp. Active/M: / Yes Alarm Counter: 00000 x High Condensing Temp. Active/M: / Yes Alarm Counter: 00000 x</pre>	<pre>Heat Pump Alarms Probes Active/M: Yes / Yes Alarm Counter: - x Act Mem Water: No / No Antifreeze: No / No Outdoor: No / No</pre>
<pre>Heat Pump Alarms Low Evaporating Temp. Active/M: / Yes Alarm Counter: 00000 x Antifreeze Active/M: / Yes Alarm Counter: 00000 x</pre>	<pre>Heat Pump Alarms High Pressure Switch Active/M: Yes / Yes Alarm Counter: 00000 x Low Pressure HP side Active/M: Yes / Yes Alarm Counter: 00000 x</pre>
<pre>Heat Pump Alarms Fan Thermal Active/M: Yes / Yes Alarm Counter: 00000 x Compressor Thermal Active/M: Yes / Yes Alarm Counter: 00000 x</pre>	<pre>Heat Pump Alarms DC Drive Alarm Active/M: Yes / Yes Alarm Counter: 00000 x Online/M: No / No Press PRG Key to DC Drive Alarm Menu</pre>

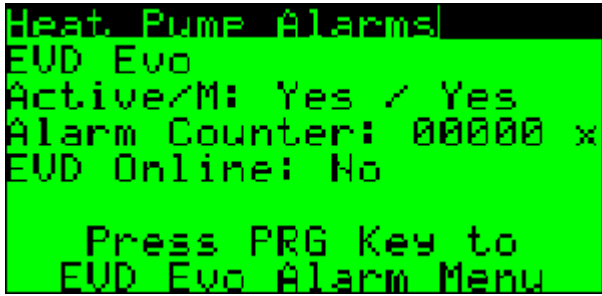

Parameter:	Range/F.:	Unit	Description
Active	No Yes	-	No: Alarm is not active. Yes: Alarm is actually active.
/M (Memory)	No Yes	-	No: Alarm is not active in memory Yes: Alarm is active in memory, control system is waiting minimum compressor Off time for recovery.
Alarm Counter	0 32000	-	Shows how many alarms of this type happened during unit operation from last counter reset.

Note: For DC Drive and EVD Evo alarms it is possible to enter detailed alarm menu pressing PRG key. You can be asked to enter detailed alarm menu to assist with problem recognition before visit of the service dealer.

4.4 Warnings

Following alarms are not causing unit to stop, but some unit functions could be limited.

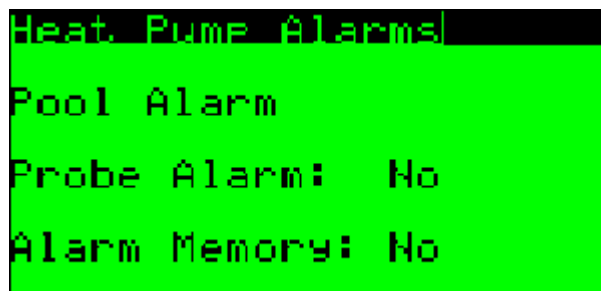
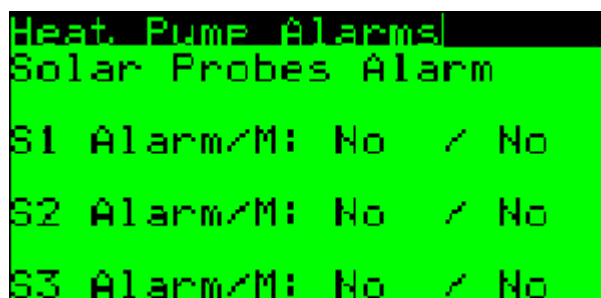
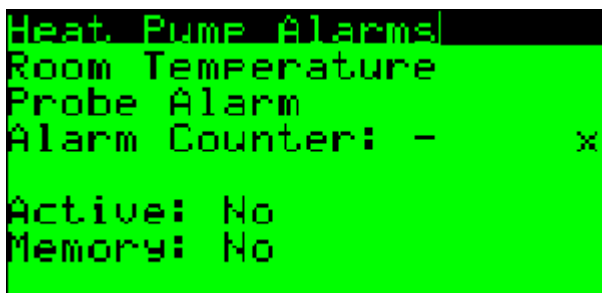
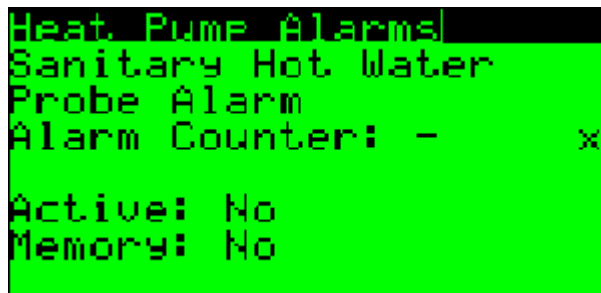
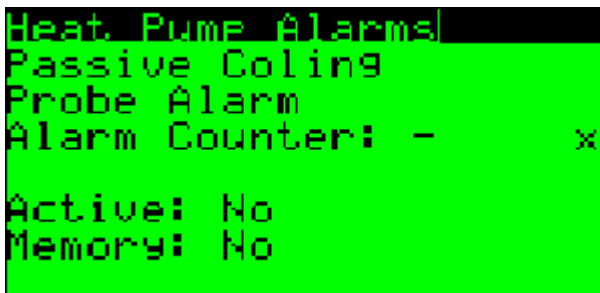

4.5 To reset alarms

All alarms are reset automatically if the count of one type does not reach 3 in 1 operating hour of the compressor.

4.6 Manual reset

The manual reset is carried out by entering the alarm menu after pressing the ALARM key. Additional pressing of the ALARM key on any alarm display performs Manual Reset

5 What to do if....

5.1 After power is on, the backlighting of the ALR key flashes

It is a normal operating state. The operation of the heat pump is restored after 6 minutes, unless any of the alarms is really active. During this period, all alarms on the alarm screen are displayed as active.

5.2 The main screen with icons shows the symbol flashing

It informs that the regular maintenance period for the unit has elapsed. This situation is NOT ALARM and unit continues in normal operation. After typical compressor time in operation, it is recommended refrigerant circuit service inspection. Typical time is 3000 operating hours, therefore we recommend service inspection in 6 months from service icon appearing.

5.3 The symbol is lit

It indicates the high electric power tariff or remote Off.

5.4 The backlighting of the ALARM key flashes

It informs about an active alarm. Press this key shortly to display the type of the alarm. If the key keeps flashing, automatic reset will be performed and the unit will be put into operation in 6 minutes.

5.5 The ALARM key is lit steadily

The operation of the unit has been blocked as the same active alarm has been detected 3x during 1 operating hour of the compressor.

Press the ALARM key to display the type of the alarm. Refer to the table „What to do in the case of difficulties“ as it must be a more serious failure.

Reset the unit manually according to Chapter 4.6.

5.6 Active icon

The outdoor temperature has dropped below the application limit of the compressor. The compressor is turned off and the heating function is taken over by both of the heating elements. When the outdoor temperature rises above the limit, the compressor will be restarted automatically.

5.7 Defrosting icon flashes

It informs that the temperature conditions to activate defrosting have been met, however, the necessary time between the defrosting cycles has not elapsed yet. It is a normal operating state.

5.8 Defrosting icon is steadily lit

It informs that the defrosting cycle is in progress. At first the compressor and fan are stopped, next the reverse valve is activated and then the compressor is restarted. The defrosting cycle is completed by starting the fan and switching the reversing valve into the heating mode. During this mode the steam/fog could appears in the area of the outdoor unit.

5.9 E! appears on the Main Screen

Safety thermostat of the electric heater was activated and heater could not be switched on. It is necessary to open the front cover and manually reset this device. Before resetting, please check water inlet filter strainer, sufficient heating water filling and pressure.

5.10 Pump symbol is flashing on the Main Screen



When icon is flashing more than 10s after the circulating pump start, the flow did not start and pump was switched off to protect it from damaging. This situation is called "Pump Alarm". System tries to restart the pump each compressor off time. This situation is usually connected to "Flow Alarm". Please check water inlet filter strainer, sufficient heating water filling and pressure.

6 Switchboard

The switchboard is accessible after the main switch is off and the front door of the heat pump is opened. The switchboard comprises all power cut-out devices and electronics. The layout is presented in the following figure:

6.1 AirMaster, EasyMaster, AquaMaster

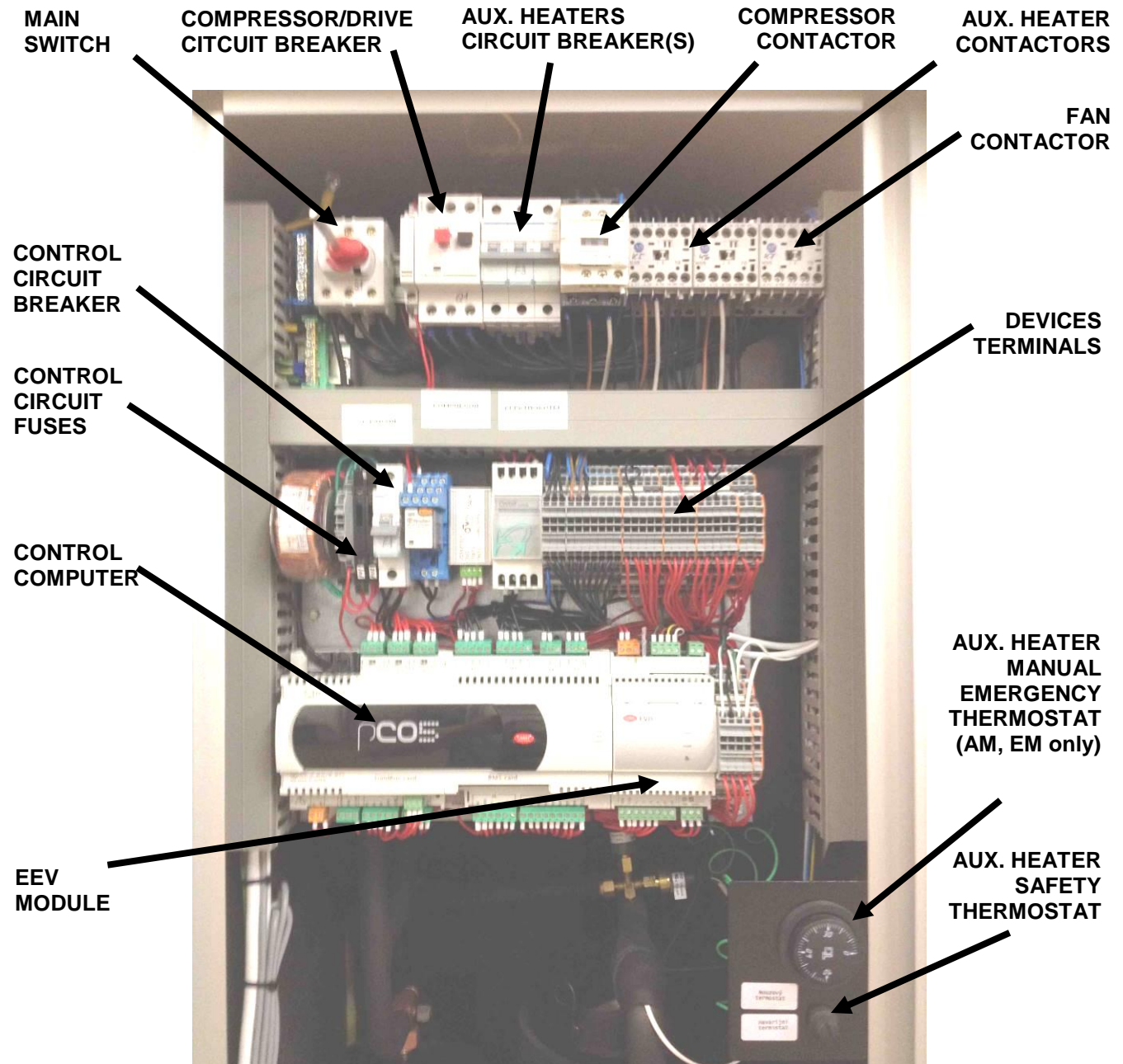

WARNING:
BEFORE OPENING THE FRONT COVER, DISCONNECT THE POWER SUPPLY TO THE UNIT IN THE HOUSE MAIN ELECTRIC DISTRIBUTOR !

6.2 BoxAir

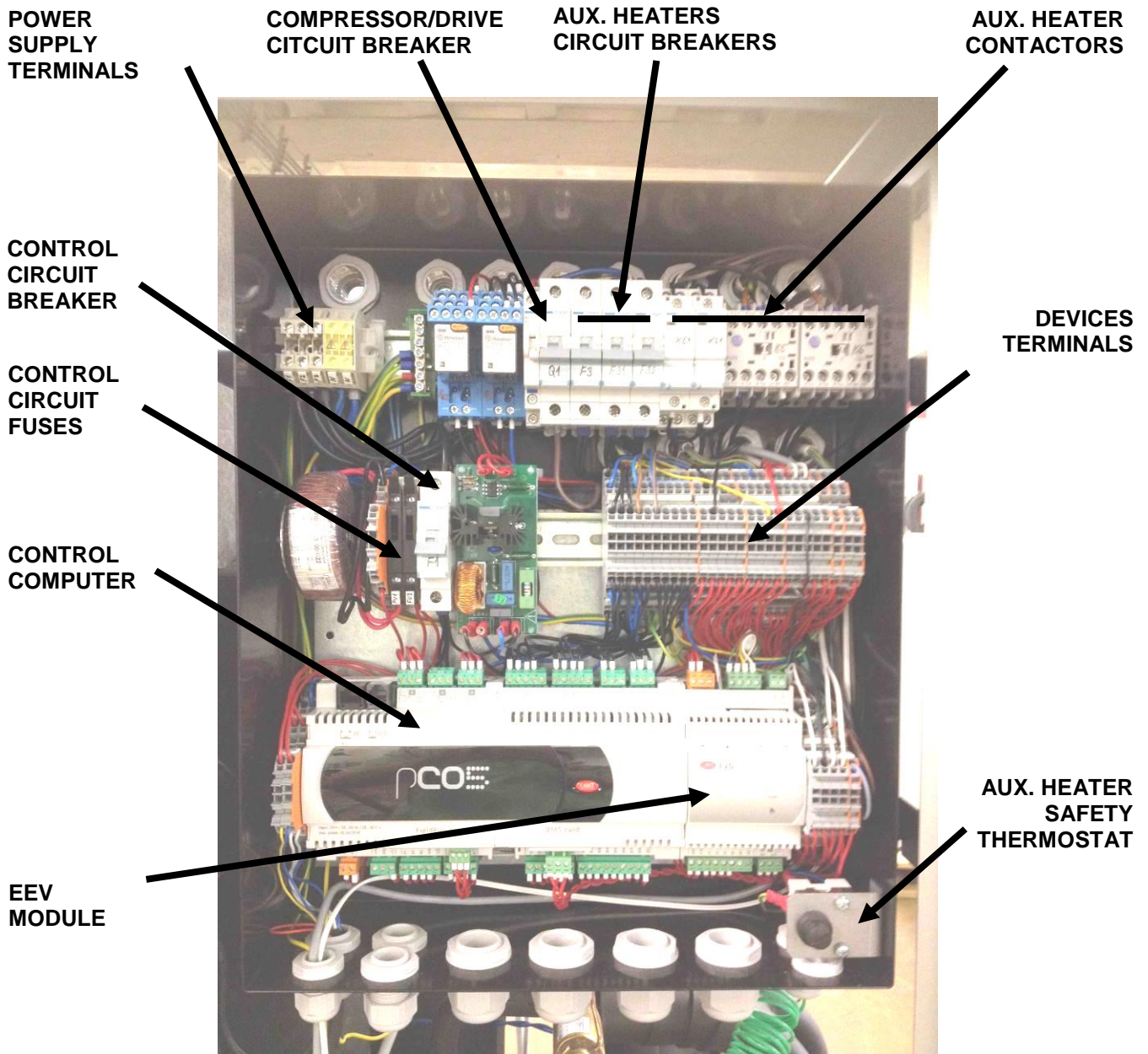

WARNING:
BEFORE OPENING THE FRONT COVER, DISCONNECT THE POWER SUPPLY TO THE UNIT IN THE HOUSE MAIN ELECTRIC DISTRIBUTOR !

6.3 Main switch

It is used to turn off the power supply leading to the heat pump switchboard.

6.4 Control circuit breaker

It protects the control devices, circulating pumps, etc.

6.5 Control Circuit Fuses

There are 2 fuses for protecting the transformer. The first is on high voltage side and the second is on the low voltage side. Please check supplied wiring diagram for correct fuse sizing. From production there is always 1 spare fuse – both sides inside the fuse box.

6.6 Auxiliary Heater Safety Thermostat

It is used to block the heaters in the case of its overheating (more than 70°C). For units with integrated storage tank also auxiliary heater circuit breaker is tripped. If this protection is activated, it is necessary to unscrew the thermoregulator plastic cover (anti-clockwise) and press the button located under the cover. If this activation occurred, inform please the installation company about this event.

6.7 Emergency Auxiliary Heater Manual Thermostat

The purpose of the emergency thermoregulator is to ensure emergency operation in the case of compressor outage. The reset is done by turning the thermoregulator to the desired temperature of heating water. By default, the maximum temperature of the thermoregulator has been inhibited to 50°C.

6.8 Auxiliary Heater Circuit Breaker

It is the electric protection element for electric heating rods. The failure may happen for two reasons. Either it is due to excessively heated integrated storage vessel, refer to Chapter 6.6, or there is a short circuit in the electric circuit of the rods. In either case, contact the installation company should a failure like this occurs.

6.9 Compressor circuit breaker

It is a starting circuit breaker for the compressor motor with integrated thermal protection for winding. The manufacturer of the heat pump has adjusted the maximum service current for the compressor on the circuit breaker. It is not allowed to modify this setting. If the service current is adjusted incorrectly, the compressor may get damaged.

7 Troubleshooting

7.1 Water/Water, Brine/Water Heat Pumps

The following chart lists alarms and activities of the operator to rectify the error state.

CODE	Meaning	Control action	Reason	Before you call service
AL01	Low pressure	Switches off compressor and brine circulator	Low closed loop temperature, evaporator freezing, brine circulator malfunction, full closed loop strainer	Switch off unit, clean closed loop strainer, check brine pressure of the closed loop, repeated problem - call service
AL02	High pressure PT	Switches off compressor and brine circulator	Too high water temperature, full water strainer, water circulator malfunction	Decrease requested water temperature, check deaerating and water filling, clean water strainer, repeated problem - call service
AL03	High Discharge Temperature	Switches off compressor and brine circulator	Too high water temperature, full water strainer, water circulator malfunction. Could be caused also from slight refrigerant leaking, or temperature probe problem (AL10)	Decrease requested water temperature, check deaerating and water filling, clean water strainer, repeated problem - call service
AL04	High Condensing Temperature in heating/cooling mode	Switches off compressor and brine circulator	Too high water/brine temperature, full water/brine strainer, water/brine circulator malfunction	Decrease requested water temperature, check deaerating and water/brine filling, clean water/brine strainer, repeated problem - call service
AL05	Low Evaporating Temperature heating/cooling mode	Switches off compressor and brine circulator	Low closed loop/cooling water temperature, evaporator freezing, brine/water circulator malfunction, full closed loop/water strainer	Switch off unit, clean closed loop/water strainer, check brine/water pressure, repeated problem - call service
AL06	Antifreeze water protection	Switches off compressor and brine circulator	Low heating/cooling water temperature	Could be caused during long electricity supply problem, or by low water temperature in cooling mode. Wait for heating of the water by auxiliary heater, increase requested water temperature if cooling mode.
AL07	Brine Pump Malfunction (AQ120.2, 150.2, 180.2 only)	Switches off compressor and brine circulator	Brine circulator motor overheating problem, or circuit breaker activation.	Call service

CODE	Meaning	Control action	Reason	Before you call service
AL08	Compressor Thermal Protection	Switches off compressor and brine circulator	Too high water temperature, power supply problem - missing phase, compressor motor malfunction	Switch on compressor circuit breaker, call service, if problem returns.
AL09	Low cooling/heating water flow	Switches off compressor and brine circulator	Circulator malfunction, full strainer cooling/heating water	Switch unit off, check water strainer. Repeated problem - call service
AL10	Temperature probe problem	Switches off compressor and brine circulator	Probe malfunction	Call service
AL11	High Pressure Switch	See AL01, AL02	See AL01, AL02	See AL01, AL02
AL12	Low Pressure HP Side	See AL01, AL02	See AL01, AL02	See AL01, AL02
AL13	DC Drive Alarm, Inverter units only	Switches off compressor and brine circulator	Compressor DC Drive Error	Restart unit power supply, if problem returns, please call service
AL14	EVD Evo Alarm	Switches off compressor and brine circulator	Malfunction of EVD Evo module	Restart unit power supply, if problem returns, please call service

7.2 Air/Water Heat Pumps

The following chart lists alarms and activities of the operator to rectify the error state.

CODE	Meaning	Control action	Reason	Before you call service
AL 01	Low pressure	Switches off the compressor and fan	Extremely low temperature of the outdoor air (below -20°C), freezing of the evaporator, operating failure of the fan	Wait for the error status to come to an end, in the case of the freezing of the evaporator, wait for the starting of the unit and perform a manual defrost; if the error occurs repeatedly, contact the installation company
AL 02	High pressure PT	Switches off the compressor and fan	Too high a temperature of the heating water	Reduce the required heating water temperature, check the bleeding and filling of the system, and check and clean the heating water filter; report the error to the installation company if it occurs repeatedly
AL 03	High Discharge Temperature	Switches off the compressor and fan	This error may be caused by insufficient coolant filling or its minor leaks; it may also be caused by a high temperature of the heating water or an extremely low outdoor air temperature. This error also occurs in the case of a sensor failure (AL 10)	Reduce the required heating water temperature, check the bleeding and filling of the system, and check and clean the heating water filter; report the error to the installation company if it occurs repeatedly
AL 04	High Condensing Temperature in heating/cooling mode	Switches off the compressor and fan	In the thawing mode, too high a temperature has been set for the end of thawing; in the cooling mode, a failure of the fan	Check the outdoor unit, and perform a manual reset; the installation company must be contacted
AL 05	Low Evaporating Temperature heating/cooling mode	Switches off the compressor and fan	Extremely low temperature of the outdoor air (below -20°C), freezing of the evaporator, operation failure of the fan	Wait for the error status to come to an end; in the case of the freezing of the evaporator, wait for the starting of the unit and perform a manual thawing; if the error occurs repeatedly, contact the installation company

CODE	Meaning	Control action	Reason	Before you call service
AL 06	Antifreeze water protection	Switches off the compressor and fan	Low temperature of the heating water	Check the circuit-breaker of the built-in electric boiler; check whether the cooling mode has not been activated by mistake
AL 07	Fan Thermal Protection	Switches off the compressor and fan	Fan overloading, faulty fan	Check the outdoor unit, and perform a manual reset; the installation company must be contacted
AL 08	Compressor Thermal Protection	Switches off the compressor	Too high a temperature of the heating water, incorrect setting of the heat protection of the compressor, faulty compressor	Reset the circuit-breaker of the compressor; contact the installation company
AL 09	Low cooling/heating water flow	Switches off the compressor and fan	Circulation pump error, clogged heating water filter	Check and clean the heating water filter. If the error occurs repeatedly, contact the installation company
AL 10	Temperature probe problem	Switches off the compressor and fan	Faulty sensor	Contact the installation company.
AL11	High Pressure Switch	See AL01, AL02	See AL01, AL02	See AL01, AL02, always call service
AL12	Low Pressure HP Side	See AL01, AL02	See AL01, AL02	See AL01, AL02, always call service
AL13	DC Drive Alarm, Inverter units only	Switches off compressor and fan	Pressure transducer malfunction	Call service
AL14	EVD Evo Alarm	Switches off compressor and fan	Malfunction of EVD400 module	Call service

7.3 Reseting Circuit Breakers

Please check the chapter “6 Switchboard” to find correct device and use device switch to reset it.

WARNING:

BEFORE OPENING THE FRONT COVER, DISCONNECT THE POWER SUPPLY TO THE UNIT IN THE HOUSE MAIN ELECTRIC DISTRIBUTOR !

7.4 Reseting the Auxiliary Heater Safety Thermostat

Activation of this safety device is signalized by appearing the “E!” symbol on the Main Screen. Please check the chapter “6 Switchboard” to find device location inside Your unit. If this protection is activated, it is necessary to unscrew the thermoregulator plastic cover (anti-clockwise) and press the button located under the cover. If this activation occurred, inform please the installation company about this event.

WARNING:

BEFORE OPENING THE FRONT COVER, DISCONNECT THE POWER SUPPLY TO THE UNIT IN THE HOUSE MAIN ELECTRIC DISTRIBUTOR !

7.5 Defrost Cycle (Air/Water only)

Due to the principle of operation of Air/Water Heat Pumps, there is air humidity condensation or ice creation on the outdoor unit heat exchanger. From this reason, control system is continuously checking unit efficiency and when snow/ice layer is too big, the defrost cycle is initiated.

Firstly the compressor and fan are stopped, next the reverse valve is activated and then the compressor is restarted. The defrosting cycle is completed by starting the fan and switching the reversing valve into the heating mode. During this mode the steam/fog could appear in the area of the outdoor unit.

7.5.1 Activating of the Manual Defrost

Defrosting cycle is performed automatically by the control system. From reason of extreme weather conditions with combination of power supply malfunction, the standard automatic procedure might not be sufficient to fully remove the snow/ice from heat exchanger. From this reason it is possible to activate the defrost cycle manually from pDG display, pressing the UP and DOWN key simultaneously.

Manual defrost could be also activated from the “Defrost Info” mask, please see chapter 3.2.8.1. Reversible units could be also defrosted by setting the unit to the Cooling Function, please see chapter 3.2.1 “Setting Unit Operation”.

8 Declaration of Conformity



MasterTherm

Master Therm CZ s.r.o.

Václavské Náměstí 819/43, 110 00 Praha 1, Czech Republic

ID: 25419714



EC DECLARATION OF CONFORMITY

acc. to §22 act no. 22/1997 Sb. as ammended by the act no.71/2000 Sb

Product: Heat Pump air/water AirMaster, EasyMaster, BoxAir, BoxAir Inverter

Models: AM3015Z, AM3021Z, AM3030Z, AM3038Z, AM3045Z
AM3060.2Z, AM3076.2Z, AM3090.2Z
AM3130Z, AM3138Z, AM3145Z, AM3160.2Z, AM3176.2Z, AM3190.2Z
EM17Z, EM22Z, EM26Z, EM30Z, EM37Z, EM45Z
BA17Z, BA22Z, BA22I, BA26Z, BA30Z, BA30I, BA37Z, BA45Z
BA17Z1, BA22Z1, BA26Z1, BA30Z1, BA37Z1

Manufacturer: Master Therm CZ s.r.o., Praha, ČR

Product Description:

Appliance for energy trasfer from Renewable Energy Sources to Heating, Cooling and Sanitary Hot Water.

Declares that the components of the above mentioned units are conform to the following directives and standards:

NV č.163/2002 Sb.
ČSN EN 60335-2-40, ČSN EN 60335-1, ČSN ISO 11200
ČSN EN 378-1 až 4, ČSN EN 13136, ČSN EN 12263
ČSN EN 60704-2-2, ČSN EN 14511-2, -3, -4, ČSN EN 255-3
NV č.616/2006, ČSN EN 55011

Conformity: according to §7 art. 2 government directive no.163/2002 Sb.

No. of sheets: 1



Praha

1.7.2009

Ing. Karel Guzek
company executive



EC DECLARATION OF CONFORMITY

acc. to §22 act no. 22/1997 Sb. as amended by the act no.71/2000 Sb

Product: Heat Pump water/water AquaMaster, AquaMaster Inverter

Models: AQ17Z, AQ22Z, AQ22I, AQ26Z, AQ30Z, AQ30I, AQ37Z, AQ45Z, AQ45I, AQ60Z, AQ60I, AQ75Z, AQ90Z, AQ120.2Z, AQ150.2Z, AQ180.2Z, AQ17Z1, AQ22Z1, AQ26Z1, AQ30Z1, AQ37Z1, AQ50Z1, AQ60Z1

Manufacturer: Master Therm CZ s.r.o., Praha, ČR

Product Description:

Appliance for energy transfer from Renewable Energy Sources to Heating, Cooling and Sanitary Hot Water.

Declares that the components of the above mentioned units are conform to the following directives and standards:

NV č.163/2002 Sb.
ČSN EN 60335-2-40, ČSN EN 60335-1, ČSN ISO 11200
ČSN EN 378-1 až 4, ČSN EN 13136, ČSN EN 12263
ČSN EN 60704-2-2, ČSN EN 14511-2, -3, -4, ČSN EN 255-3
NV č.616/2006, ČSN EN 55011

Conformity: according to §7 art. 2 government directive no.163/2002 Sb.

No. of sheets: 1



Praha 1.7.2009

Ing. Karel Guzek
company executive

9 Safety and Environment Protection

9.1 Greenhouse Gas

Heat Pumps contains greenhouse gas – refrigerant charge listed in Kjoto Protocol. Venting refrigerant into atmosphere is not allowed.

9.2 Hermetical Sealing

All units are hermetically sealed system after installation.

10 Service Menu

Service menu allows detailed parameters setting. Menu is divided into separate parts according to different heat pump functions.

To enter the service menu, press PRG on the main (icon) screen. Password dialog appears. Enter the correct password to reach service level.

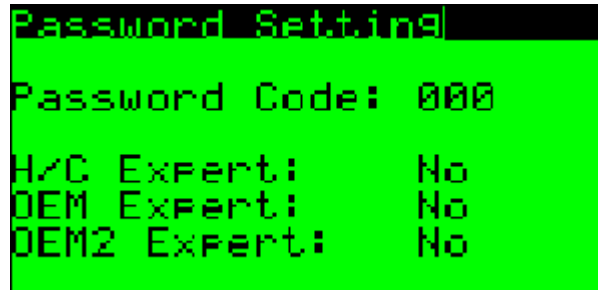

Parameter:	SP	Range/F.:	Unit	Description
Password Code	-	0-999	-	Password Code, 999 H/C, *
H/C Expert	-	Yes/No	-	H/C Expert access level
OEM Expert	-	Yes/No	-	OEM Expert access level
OEM2 Expert	-	Yes/No	-	OEM2 Expert access level

* Please ask Master Therm for other codes

Warning: Entering OEM/OEM2 access levels allows editing parameters, which incorrect setting could damage or destroy heat pump system.

Pressing PRG opens the Service Menu.

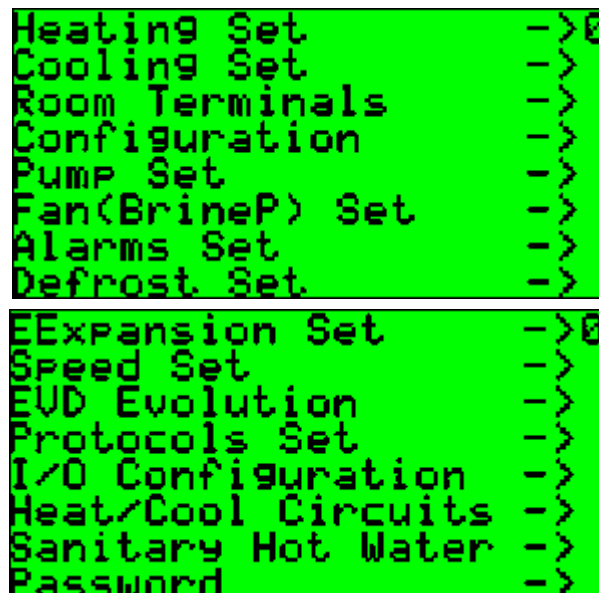

Move cursor to required function setting and press ENTER.

10.1 Heating Set

General setting of the main (heat pump) heating circuit.

10.1.1 Weather compensation Heating

```

Heating Setting
Heating Curve Point A
Outdoor Temp.: 20.0 °C
Water Temp.: 20.0 °C
Heating Curve Point B
Outdoor Temp.: -15.0 °C
Water Temp.: 30.0 °C
    
```

Weather compensation parameters could be shown on following picture:

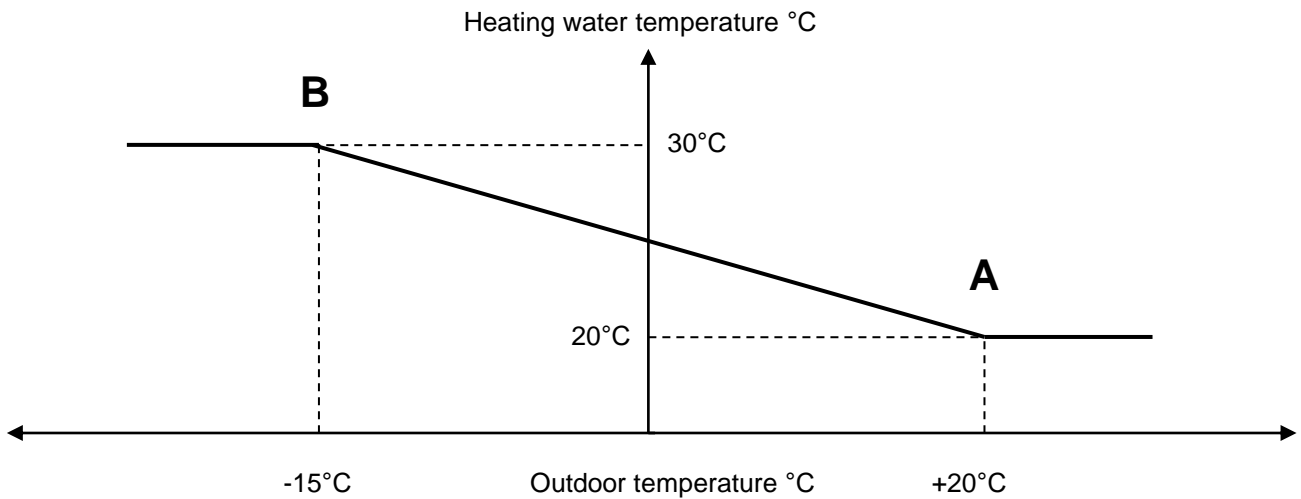

Parameter:	SP	Range/F.:	Unit	Description
Point A Outdoor Temperature	A35	-20.0 30.0 F: 20.0	°C	Point A, outdoor temperature definition.
Point A Water Temperature	A37	*20.0 47.5 F: 20.0	°C	Point A, water temperature definition. Requested heating water temperature for defined Point A outdoor temperature. 20.0°C is typical setting for Under Floor Heating (UFH) and Radiators.
Point B Outdoor Temperature	A36	-20.0 30.0 F: -15.0	°C	Point B, outdoor temperature definition.
Point B Water Temperature	A38	*20.0 47.5 F: 30.0	°C	Point B, water temperature definition. Requested heating water temperature for defined Point B outdoor temperature. 30.0°C is typical setting for UFH. 40.0°C is typical setting for Radiators.

* The real temperature range is limited according to the setting during commissioning.

10.1.1.1 Room Compensation

Pressing PRG on 10.1.1 opens Room compensation screens.

```

Compensation Setting
pAD Active:No
Room Temp.: 00.0 °C
Room Set Temp.00.0 °C
Actual Compensation
Heating: 00.0 %
Cooling: 00.0 %
  
```

```

Compensation Setting
Room Temp. Probe
Not Used
Water Compensation
Heating: 05.0 °C
Cooling: 05.0 °C
Prop. Band: 02.0 °C
Integr. Time: 0000 s
  
```

Parameter:	SP	Range/F.:	Unit	Description
pAD Active	D242	Yes/No	-	pAD01 Active status
Room Temp.	A211	-99.9/99.9	°C	Actual room temperature
Room Set Temp.	-	-99.9/99.9	°C	Room setpoint temperature
Actual Compensation Heating	A198	-99.9/99.9	°C	Result of room compensation on requested water temperature Heating
Actual Compensation Cooling	A199	-99.9/99.9	°C	Result of room compensation on requested water temperature Cooling.
Room Temp. Probe	-	B1- B5/pCO5, B1- B4/pCOe	-	Room temperature probe selection. If pAD01 is connected, keep Not Used
Water Compensation Heating	A196	-99.9/99.9 F: 5.0	°C	Maximum/Minimum water temperature compensation in heating mode
Water Compensation Cooling	A197	-99.9/99.9 F: 5.0	°C	Maximum/Minimum water temperature compensation in cooling mode
Prop. Band	A200	-99.9/99.9 F: 2.0	°C	Room temperature proportional band for water compensation calculation
Integr. Time	I180	0-9999 F: 0	S	Integration time of the water compensation calculation. Keep 0 for Proportional function only

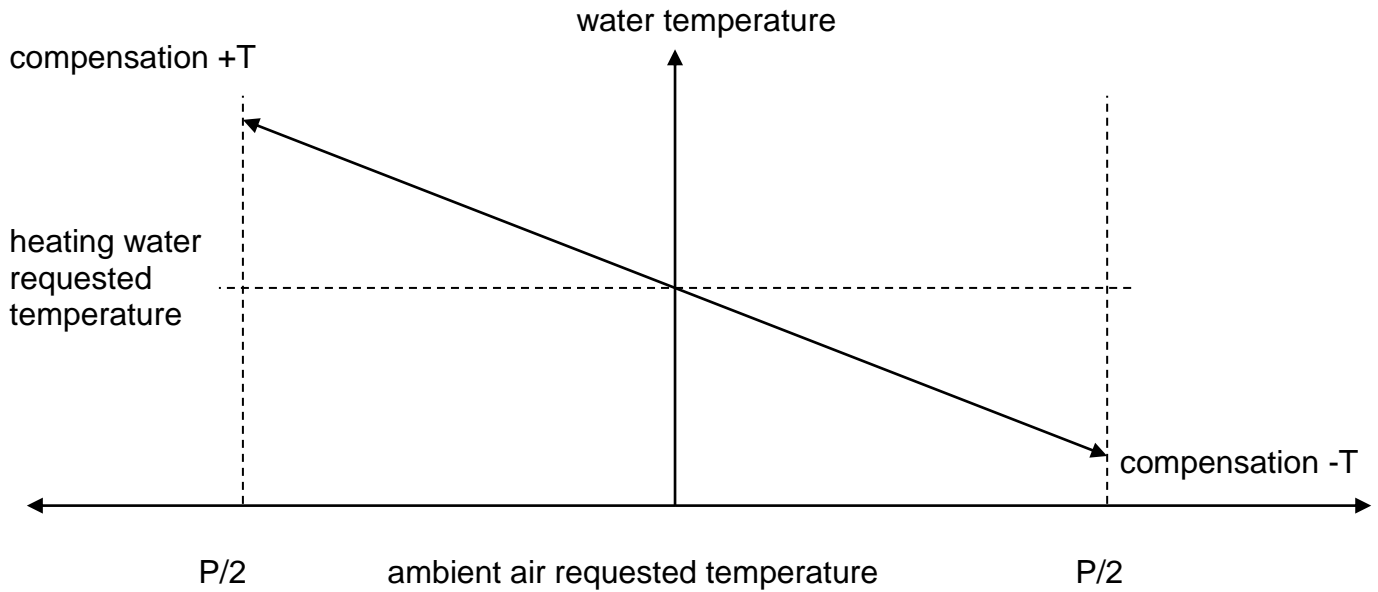

Picture above, shows principle of room compensation. Calculated water compensation value is add to weather compensation value of the requested water temperature.

When room probe is not installed, nor the pAD01, the system automatically supposes room temperature 20.0°C. When requested room temperature is adjusted by the user, water compensation is also recalculated with virtual room temperature 20.0°C.

10.1.2 Water/Air Limits Heating

```

Heating Settings
Setpoint Water Limit
Minimum Temp.: 20.0 °C
Maximum Temp.: 50.0 °C
Setpoint Air Limit
Minimum Temp.: -30.0 °C
Maximum Temp.: 30.0 °C
    
```

Parameter:	SP	Range/F.:	Unit	Description
Water Minimum Temp.	A299	-99.9/99.9 F: 20.0	°C	Minimum water temperature limit for the unit setpoint
Water Maximum Temp.	A207	-99.9/99.9 F: 50.0	°C	Maximum water temperature limit for the unit setpoint
Air Minimum Temp.	A300	-99.9/99.9 F: -30.0	°C	Minimum Air temperature limit for the unit setpoint. This is not the limit for unit operation.
Air Maximum Temp.	A301	-99.9/99.9 F: 30.0	°C	Maximum Air temperature limit for the unit setpoint. This is not the limit for unit operation.

10.1.3 Compressor Hysteresis / Offset Heating

```

Heating Settings
Compressor
Hysteresis:      02.5 °C
Compressor 2
Offset:          02.5 °C
  
```

Parameter:	SP	Range/F.:	Unit	Description
Compressor Hysteresis	A43	-99.9/99.9 F: 2.5	°C	Compressor control hysteresis.
Compressor 2 Offset	A302	-99.9/99.9 F: 2.5	°C	Negative offset of the Compressor 2 setpoint for double compressor units.

10.1.4 Compressor limit

```

Heating Settings
Outdoor Temperature
Compressor Limit
Water 30°C:      -18.0 °C
Water 50°C:      -12.0 °C
Actual Limit:    -12.0 °C
  
```

Parameter:	SP	Range/F.:	Unit	Description
Water 30°C	A44	-99.9/99.9 F: *	°C	Compressor operation limit for water temperature 30°C.
Water 50°C	A45	-99.9/99.9 F: *	°C	Compressor operation limit for water temperature 50°C.
Actual Limit	A46	-99.9/99.9	°C	Actual calculated limit according to outdoor temperature.

* Different for different units

Unit:	Water 30°C	Water 50°C
AQ	-99.9	-99.9
AM	-15.0	-15.0
EM	-15.0	-12.0
BA	-15.0	-12.0
BAI	-15	-7.0

Control works with hysteresis 3.0°C.

Example: Calculated limit: -15.0°C
 Temperature OFF: -18.0°C
 Temperature ON: -15.0°C

10.1.5 Auxiliary Heater Limit

```

Heating Setting
Auxiliary Heater
Outdoor Temperature
Limit: 00.0 °C
Actual Integration
Value: 0000.0 °C*min
    
```

Parameter:	SP	Range/F.:	Unit	Description
Outdoor Temperature Limit	A39	-99.9/99.9 F: 0	°C	Outdoor temperature limit for enabling auxiliary heater.
Actual Integration Value	A10	-9999.9/ 9999.9	°C.min	Actual value of calculated missing heat integration.

10.1.6 Auxiliary Heater Control

```

Heating Setting
Auxiliary Heater
Hysteresis: 02.5 °C
Offset: 02.5 °C
Integral °C*min
Activation: 050.0
Deactivation: 010.0
    
```

Parameter:	SP	Range/F.:	Unit	Description
Hysteresis	A27	-99.9/99.9 F: 2.5	°C	Heater control hysteresis.
Offset	A28	-99.9/99.9 F: 2.5	°C	Heater setpoint offset from compressor setpoint.
Integral Activation	A40	0/999.9 F: 50.0	°C.min	When missing heat integration reaches this value, heater is activated
Integral Deactivation	A41	0/999.9 F: 10.0	°C.min	When missing heat integration reaches this value(negative) , heater is deactivated

10.1.7 Heater Antifreeze function

```

Heating Setting
Auxiliary Heater
Antifreeze Function
Heating Mode: 23.0 °C
Cooling Mode: 09.0 °C
Actual: Heating
    
```

Parameter:	SP	Range/F.:	Unit	Description
Antifreeze Heating Mode	A42	-99.9/99.9 F: *	°C	Antifreeze water setpoint for activation of auxiliary heater in heating mode, below outdoor defrost limit.
Antifreeze Cooling Mode	A151	-99.9/99.9 F: *	°C	Antifreeze water setpoint for activation of auxiliary heater in cooling mode, above outdoor defrost limit.
Actual	-	Heating/ Cooling	-	Shows actual mode for antifreeze heater function.

* Different for different units

Unit:	Heating Mode	Cooling Mode
AQ	15.0	15.0
AM	23.0	13.0
EM	23.0	13.0
BA	15.0	10.0
BAI	15.0	10.0

Control works with negative hysteresis.

10.1.8 Auxiliary Heater HW config

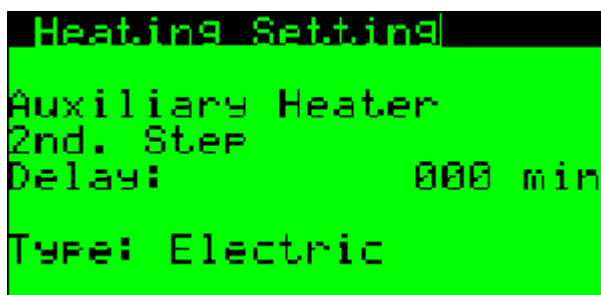

Parameter:	SP	Range/F.:	Unit	Description
2nd. Step Delay	15	0/999 F: 0	min	Delay of the 2nd. heater stage. When set to 0, 2nd. stage is not activated with running compressor.
Type	-	Electric/Gas F: Electric	-	Specifies heater type. If Gas is selected, heater works beside compressor when unit remotely OFF (tariff control)

10.1.9 Heating Control Logic

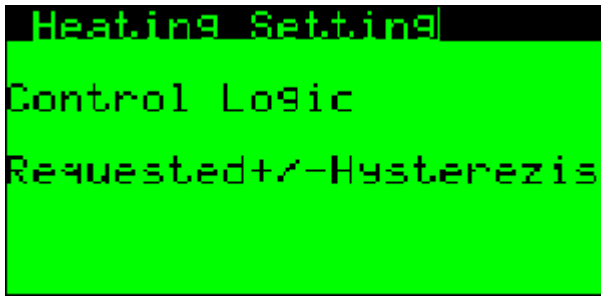

Parameter:	SP	Range/F.:	Unit	Description
Control Logic	D30	0: +/- 1: - F: 0	-	Main heating circuit control logic. When 0, water is controlled in logic setpoint +/- hysteresis. When 1, water is controlled in logic setpoint - hysteresis

10.1.10 Geometric temperature



Parameter:	SP	Range/F.:	Unit	Description
Delta T	A303	0/9.9 F: 0.5	°C	Change of the geometric temperature each period of geometric time (integration step).
Geometric Time	I43	0/9999 F:1800	s	Time period for geometric temperature calculation (integration period).
Outdoor	A3	-99.9/99.9	°C	Actual outdoor temperature.
Geometric	A34	-99.9/99.9	°C	Actual geometric temperature. Note: geometric temperature is reset to outdoor temperature on powering unit ON

10.1.11 Automatic Changeover

```

Heating Setting
Winter / Summer
Automatic Changeover

Outdoor Temperature
Winter Mode: 13.0 °C
Summer Mode: 17.0 °C
Auto Status: Summer
    
```

Parameter:	SP	Range/F.:	Unit	Description
Winter Mode	A82	-20.0 40.0 F:+13.0	°C	Outdoor temperature for activation of Winter Mode. Below this temperature, Winter Mode is activated.
Summer Mode	A83	-20.0 40.0 F:+17.0	°C	Outdoor temperature for activation of Summer Mode. Above this temperature, Summer Mode is activated.
Auto Status	-	Winter Summer	-	Result of the Automatic Changeover according to the setting above.

Note: The mode is not changed according to actual outdoor temperature, but geometric outdoor temperature, created inside the controller.

10.2 Cooling Set

10.2.1 Weather compensation Cooling

This display is available only for units with Cooling, or Passive Cooling (Optional Equipment). Display enables setting of the Main Cooling Weather Compensation.

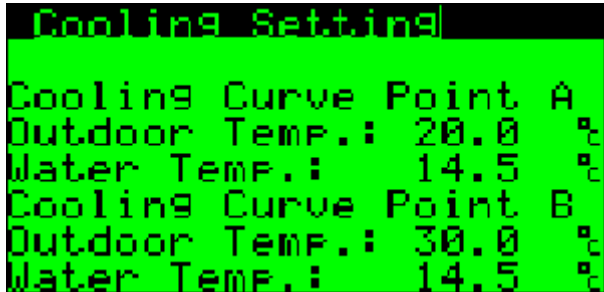

Weather compensation parameters could be shown on following picture:

Cooling water temperature °C

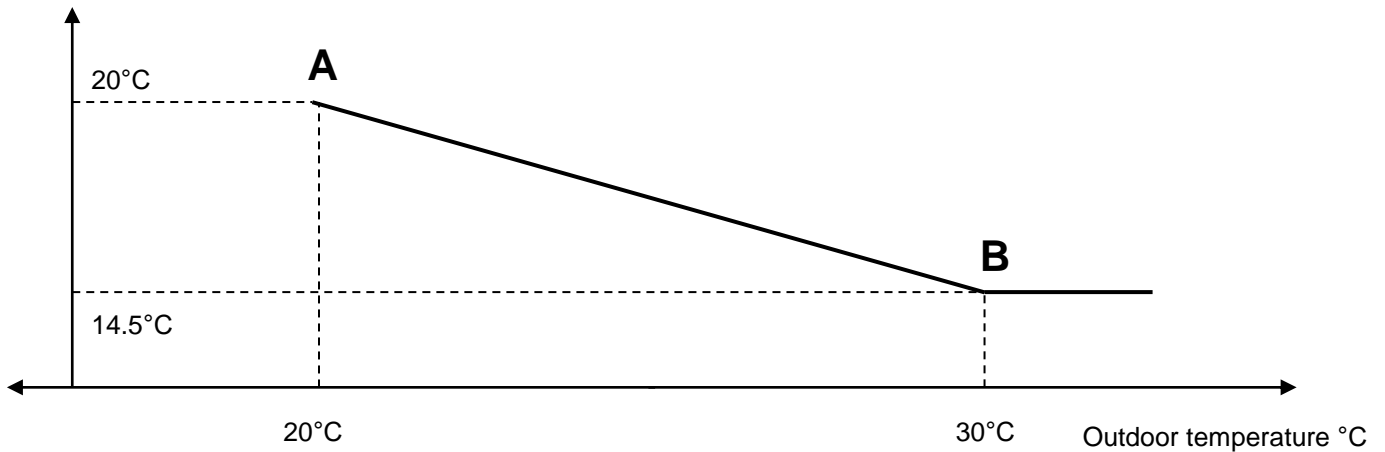

Parameter:	SP	Range/F.:	Unit	Description
Point A Outdoor Temperature	A47	10.0 40.0 F: 20.0	°C	Point A, outdoor temperature definition.
Point A Water Temperature	A49	*14.5 30.0 F: 14.5	°C	Point A, water temperature definition. Requested cooling water temperature for defined Point A outdoor temperature. 20.0°C is typical setting for Under Floor Heating (UFH) and FanCoils.
Point B Outdoor Temperature	A48	10.0 40.0 F: 30.0	°C	Point B, outdoor temperature definition.
Point B Water Temperature	A50	*14.5 30.0 F: 14.5	°C	Point B, water temperature definition. Requested cooling water temperature for defined Point B outdoor temperature. 18.0°C is typical setting for UFH. 14.5°C is typical setting for FanCoils.

* The real temperature range is limited according to the setting during commissioning. Additional limitation is possible due to the Dew Point protection if it is activated.

10.2.2 Water/Air Limits Cooling

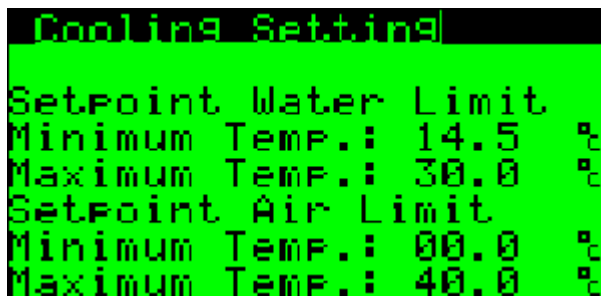

```

Cooling Setting
Setpoint Water Limit
Minimum Temp.: 14.5 °C
Maximum Temp.: 30.0 °C
Setpoint Air Limit
Minimum Temp.: 00.0 °C
Maximum Temp.: 40.0 °C
  
```

Parameter:	SP	Range/F.:	Unit	Description
Water Minimum Temp.	A305	-99.9/99.9 F: 14.5	°C	Minimum water temperature limit for the unit setpoint
Water Maximum Temp.	A306	-99.9/99.9 F: 30.0	°C	Maximum water temperature limit for the unit setpoint
Air Minimum Temp.	A307	-99.9/99.9 F: 0.0	°C	Minimum Air temperature limit for the unit setpoint. This is not the limit for unit operation.
Air Maximum Temp.	A308	-99.9/99.9 F: 40.0	°C	Maximum Air temperature limit for the unit setpoint. This is not the limit for unit operation.

10.2.3 Compressor Hysteresis/Offset Cooling

```

Cooling Setting
Compressor
Hysteresis:    02.5  °C
Compressor 2
Offset:        02.5  °C
  
```

Parameter:	SP	Range/F.:	Unit	Description
Compressor Hysteresis	A51	-99.9/99.9 F: 2.5	°C	Compressor control hysteresis.
Compressor 2 Offset	A309	-99.9/99.9 F: 2.5	°C	Positive offset of the Compressor 2 setpoint for double compressor units.

10.2.4 Dew Point Control

Dew point control is function for limitation of the cooling water setpoint to avoid condensation on the cooling surface. This requires pAD room terminal with humidity probe.

```

Cooling Setting
Rel. Humidity:  000  %
Dew Point:      00.0  °C
Temp. Limit:    00.0  °C
DewP Offset:    00.0  °C
  
```

Parameter:	SP	Range/F.:	Unit	Description
Rel. Humidity	I185	0/100	%	Actual relative humidity measured by pAD01.
Dew Point	A13	-99.9/99.9	°C	Calculated dew point from relative humidity and temperature
Temp. Limit	A310	-99.9/99.9	°C	Calculated water temperature limit from dew point and dew point offset.
DewP Offset	A14	-99.9/99.9 F: 0.0	°C	Dew point offset for safety margin to avoid condensation.

10.2.5 Dew Point Control Enable/Disable (OEM)

```

Cooling Settings
DewPoint Protection:
Disabled / Not Active
DewP Offset:      00.0 °C
Rel. Humidity:    000 %
Dew Point:       00.0 °C
Temp. Limit:     00.0 °C
  
```

Parameter:	SP	Range/F.:	Unit	Description
DewPoint Protection	B196	0: Disabled 1: Enabled F: 0	-	Enabling/Disabling function.
	B197	0: Not Active 1: Active	-	Function is Active/Not Active. When probe alarm, function is not active, although it is Enabled.
DewP Offset	A14	-99.9/99.9 F: 0.0	°C	Dew point offset for safety margin to avoid condensation.
Rel. Humidity	I185	0/100	%	Actual relative humidity measured by pAD01.
Dew Point	A13	-99.9/99.9	°C	Calculated dew point from relative humidity and temperature
Temp. Limit	A310	-99.9/99.9	°C	Calculated water temperature limit from dew point and dew point offset.

10.2.6 Passive Cooling

Passive cooling function for ground source heat pumps is using ground loop energy for cooling of the house and recovering ground loop.

```

Cooling Settings
Passive Cooling:
Disabled
On Time:      0120 s
Off Time:     0360 s
Control Probe: B1/PC05
Relay: Relay 2 /PC05
  
```

Parameter:	SP	Range/F.:	Unit	Description
Passive Cooling	B276	0: Disabled 1: Enabled F: 0	-	Enabling/Disabling function.
On Time	I105	0/9999 F: 120	s	Brine pump circulation time to obtain water temperature value, higher than the setpoint.
OFF Time	I106	0/9999 F: 360	s	Brine pump OFF cycle, when temperature is too low. The brine pump although on minimum speed delivered very high cooling capacity resulting the cooling water is too cold.
Control Probe	-	B1- B5/pCO ₅ , B1- B4/pCO _e F: B2/pCO ₅	-	Control probe selection. Normally it is the main control probe, cause it is located between passive cooling heat exchanger and condenser.
Relay	-	R1- R8/pCO ₅ R1- R4/pCO _e F: R2/pCO ₅	-	Passive cooling 3 way valve selection.

10.2.7 Passive Cooling Info

```

Passive Cooling
Temperature
Actual:      00.0 °C
Requested:   00.0 °C
Rel. Humidity: 000 %
Dew Point:   00.0 °C
Pump:       Off
Output:     000.0 %
  
```

Parameter:	SP	Range/F.:	Unit	Description
Actual	A311	-99.9/99.9	°C	Actual water temperature measured by probe.
Requested	A312	-99.9/99.9	°C	Requested water temperature.
Rel. Humidity	I185	0/100	%	Actual relative humidity measured by pAD01.
Dew Point	A13	-99.9/99.9	°C	Calculated dew point from relative humidity and temperature
Pump	B277	0: OFF 1: ON	-	Brine pump operation.
Output	A313	0/100.0	%	Brine pump speed.

10.2.8 Brine Temperature Control

```

Brine Temp. Control
Enabled: No
Ctrl.Probe: Not Used
Setpoint: 05.0 °C
Hysterezis: 05.0 °C
BrineT:00.0 °C Out:No
BrineP Run: Compressor
BrineP Speed: 050.0 %
    
```

Parameter:	SP	Range/F.:	Unit	Description
Brine Control Enabled	B415	0/1 F: 0	-	Brine temperature control activation. When brine temperature reaches setpoint, compressor stops. Auxiliary heater starts beside compressor. When brine temperature reaches setpoint+hysterezis, compressor starts.
Ctrl.Probe	-	0-9 F: 0	-	Control probe selection: 0=Not Used, B1-B5/pCO ₅ , B1-B4/pCO _e
Brine Control Setpoint	A434	-99.9-99.9 F: 5.0	°C	Brine temperature control setpoint.
Brine Control Hysterezis	A435	-99.9-99.9 F: 5.0	°C	Brine temperature control hysterezis.
BrineT	A433	-99.9-99.9	°C	Real brine temperature.
Brine Control Out	B417	0/1	-	0(No)=Brine control output not active, compressor Off. 1(Yes)=Brine control output active, compressor On.
BrineP Run	B416	0/1 F: 0	-	Specifies, if brine pump is running with compressor only (0=Compressor), or brine pump is running permanently (1=Pernament)
BrineP Speed	A436	0-100.0 F: 50.0	%	Brine pump speed, when compressor is Off by brine control and pernament run is selected.

10.3 Room Terminals

Set up of the room terminals.

```

pAD 00 Status
Active: No
On/Off: PERMANENT OFF
Mode: None
Setpoint: 00.0°C
Temperature: 00.0°C
          000
Buzzer: Disabled
  
```

Parameter:	Range/F.:	Unit	Description
pAD	01, 11-16	-	pAD Identification Number. This Parameter is not adjustable. It is given by pAD Hardware Address. 01: Main Zone Room Terminal 11: Heating Circuit 1 Room Terminal 12: Heating Circuit 2 Room Terminal 13: Heating Circuit 3 Room Terminal 14: Heating Circuit 4 Room Terminal 15: Heating Circuit 5 Room Terminal 16: Heating Circuit 6 Room Terminal
Active	0: No, 1: Yes	-	Informs about pADxx staus. pADxx must be ONLINE and ENABLED to be Active.
On/Off	0: Pernament OFF 1: OFF 2: ON	-	Pernament OFF: Terminal is permanently OFF and heating/cooling of the zone is disabled. OFF: Terminal is OFF by the scheduler and heating/cooling of the zone is temporarily disabled. ON: Terminal is ON and heating/cooling of the zone is enabled.
Mode	1: Winter 2: Summer	-	For pAD 01 it has the same meaning like the main Mode of the Heat Pump. When unit is equipped with cooling or passive cooling, with Mode change also Function is changed. For pAD11 to 16, the Mode setting has no effect and Mode is forced according to the Heat Pump Mode. Heat Pump has priority to pAD11 to 16.
Setpoint	6.0 to 32.0	°C	Requested Room Temperature set by user.
Temperature	-99.9 to 99.9	°C	Real Room Temperature
Rel. Humidity	0-100	%	Real Room Relative Humidity
Buzzer	Disabled Enabled F: Disabled	-	Enables/Disables Buzzer

10.3.1 pAD Status

```
pAD 00 Status
Sleep Time: 0 Hour(s)
Setpoint Sleep: 00.0 °C
Temperature: 00.0 °C
Rel. Humidity: 000 %
```

Parameter:	Range/F.:	Unit	Description
pAD	01, 11-16	-	pAD Identification Number. This Parameter is not adjustable. It is given by pAD Hardware Address. 01: Main Zone Room Terminal 11: Heating Circuit 1 Room Terminal 12: Heating Circuit 2 Room Terminal 13: Heating Circuit 3 Room Terminal 14: Heating Circuit 4 Room Terminal 15: Heating Circuit 5 Room Terminal 16: Heating Circuit 6 Room Terminal
Sleep Time	0-9	h	Remaining time of the pAD Sleep Function.
Setpoint Sleep	6.0 – 32.0	°C	Room Temperature Setpoint for pAD Sleep Function. Temporary Room Setpoint for the Sleep Time set. When Sleep Time elapses, Setpoint is returned to standart value set on the pAD.
Temperature	-99.9 to 99.9	°C	Real Room Temperature
Rel. Humidity	0-100	%	Real Room Relative Humidity

10.3.2 pAD Scheduler

Scheduler setting consists of 2 displays.

```
pAD 00 Scheduler
pAD Clock: Mon 00:00
Enable scheduler: 0
```

```
pAD 00 Scheduler
Scheduler
time set
Mon-Fri 1 00:00 00.0 °C
          2 00:00 00.0 °C
Sat-Sun 1 00:00 00.0 °C
          2 00:00 00.0 °C
```

Parameter:	Range/F.:	Unit	Description
pAD	01, 11-16	-	pAD Identification Number. This Parameter is not adjustable. It is given by pAD Hardware Address. 01: Main Zone Room Terminal 11: Heating Circuit 1 Room Terminal 12: Heating Circuit 2 Room Terminal 13: Heating Circuit 3 Room Terminal 14: Heating Circuit 4 Room Terminal 15: Heating Circuit 5 Room Terminal 16: Heating Circuit 6 Room Terminal
pAD Clock	Mo-Su 00:00-23:59	d h:m	pAD actual time. Time is automatically synchronized with the main controller.
Enable Scheduler	0 1	-	0: Scheduler is not enabled. 1: Scheduler is enabled.
Mon-Fri time 1 2	00:00-23:59 00:00-23:59	h:m h:m	Start time of the first time zone for Monday to Friday. Start time of the second time zone for Mo to Fr.
Mon-Fri set 1 2	Off/6.0-32.0/On Off/6.0-32.0/On	°C/- °C/-	Room Setpoint, or simple On/Off request for TZ 1. Room Setpoint, or simple On/Off request for TZ 2.
Sat-Sun time 1 2	00:00-23:59 00:00-23:59	h:m h:m	Start time of the first time zone for Sat - Sun. Start time of the second time zone for Sat - Sun.
Sat-Sun set 1 2	Off/6.0-32.0/On Off/6.0-32.0/On	°C/- °C/-	Room Setpoint, or simple On/Off request for TZ 1. Room Setpoint, or simple On/Off request for TZ 2.

10.3.3 pAD Display Config

```
pAD 00 Configuration
Show Main Display:
Current Time
Show Second Display:
Current Time
```

Parameter:	Range/F.:	Unit	Description
pAD	01, 11-16	-	pAD Identification Number. This Parameter is not adjustable. It is given by pAD Hardware Address. 01: Main Zone Room Terminal 11: Heating Circuit 1 Room Terminal 12: Heating Circuit 2 Room Terminal 13: Heating Circuit 3 Room Terminal 14: Heating Circuit 4 Room Terminal 15: Heating Circuit 5 Room Terminal 16: Heating Circuit 6 Room Terminal
Show Main Display	CurrentTime Temperature Setpoint Local Temperature Humidity Setpoint Local Humidity"	-	What is shown on the main display.
Show Second Display	CurrentTime Temperature Setpoint Local Temperature Humidity Setpoint Local Humidity"	-	What is shown on the second display.

10.3.4 pAD Key Config

```

pAD 00 Configuration
Key1F: Disabled
Key2F: Disabled
Key3F: Disabled
Key4F: Disabled
Key5F: Disabled
Key6F: Disabled
  
```

Parameter:	Range/F.:	Unit	Description
pAD	01, 11-16	-	pAD Identification Number. This Parameter is not adjustable. It is given by pAD Hardware Address. 01: Main Zone Room Terminal 11: Heating Circuit 1 Room Terminal 12: Heating Circuit 2 Room Terminal 13: Heating Circuit 3 Room Terminal 14: Heating Circuit 4 Room Terminal 15: Heating Circuit 5 Room Terminal 16: Heating Circuit 6 Room Terminal
Key1F Key2F Key3F Key4F Key5F Key6F	Disabled On/Off Mode Humidity Night/Sleep Clock Temperature PRG Fan Alarm Reset	-	Key function configuration.

10.3.5 pAD Configuration

```

pAD 00 Configuration
Enabled: Yes
Hyster. Heat: 02.0 °C
Hyster. Cool: 02.0 °C
MinTemp: 06.0 °C
MaxTemp: 32.0 °C
  
```

Parameter:	Range/F.:	Unit	Description
pAD	01, 11-16	-	pAD Identification Number. This Parameter is not adjustable. It is given by pAD Hardware Address. 01: Main Zone Room Terminal 11: Heating Circuit 1 Room Terminal 12: Heating Circuit 2 Room Terminal 13: Heating Circuit 3 Room Terminal 14: Heating Circuit 4 Room Terminal 15: Heating Circuit 5 Room Terminal 16: Heating Circuit 6 Room Terminal
Enabled	Yes/No F: No	-	Enabling pADxx terminal.
Hyster. Heat	-99.9/99.9 F: 2.0	°C	Thermostat Hysteresis in heating mode.
Hyster. Cool	-99.9/99.9 F: 2.0	°C	Thermostat Hysteresis in cooling mode.
MinTemp	-99.9/99.9 F: 6.0	°C	Minimum room temperature setpoint.
MaxTemp	-99.9/99.9 F: 6.0	°C	Maximum room temperature setpoint.

10.3.6 pAD HW Setup/Info

```

pAD 00 Configuration
Address:          000
Firmware version: 0.0
HW options:      None
Clock from:      FCO
  
```

Parameter:	Range/F.:	Unit	Description
pAD	01, 11-16	-	pAD Identification Number. This Parameter is not adjustable. It is given by pAD Hardware Address. 01: Main Zone Room Terminal 11: Heating Circuit 1 Room Terminal 12: Heating Circuit 2 Room Terminal 13: Heating Circuit 3 Room Terminal 14: Heating Circuit 4 Room Terminal 15: Heating Circuit 5 Room Terminal 16: Heating Circuit 6 Room Terminal
Address	0/255	-	pAD address in network, must be the same like pAD number.
Firmware	0.0/9.9	-	Firmware version of connected pADxx.
HW options	None Clock Humid Humid+Clock	-	Shows connected pADxx equipment.
Clock from	pAD pCO F: pCO	-	Clock source for pADxx terminal.

10.3.7 pAD Debug

```

pAD 00 Debug
Mod_pAD Version: 1.4
                Address:001
MB result
01-05: 0 0 0 0 0
06-10: 0 0 0 0 0
11-15: 0
  
```

Parameter:	Range/F.:	Unit	Description
pAD	01, 11-16	-	pAD Identification Number. This Parameter is not adjustable. It is given by pAD Hardware Address. 01: Main Zone Room Terminal 11: Heating Circuit 1 Room Terminal 12: Heating Circuit 2 Room Terminal 13: Heating Circuit 3 Room Terminal 14: Heating Circuit 4 Room Terminal 15: Heating Circuit 5 Room Terminal 16: Heating Circuit 6 Room Terminal
Address	0/255	-	pAD address in network
Version	0.0/9.9	-	Firmware version of connected pADxx.
MB result For Modbus communication, Sublists 01-15	-2	-	Generic error on one or more Modbus commands. Summarizes one or more data errors from Modbus sublists.
	-1	-	Incorrect Uart settings data
	0	-	No Message
	1	-	Uart settings successfully completed
	2	-	Command successfully completed. All commands requested by sublists were successfully completed

10.3.8 pADxx Alarms

If pAD is in Alarm Status it is possible to see it on this display.

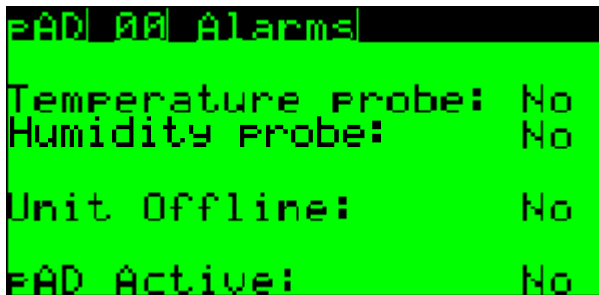

Parameter:	Range/F.:	Unit	Description
pAD	01, 11-16	-	pAD Identification Number. This Parameter is not adjustable. It is given by pAD Hardware Address. 01: Main Zone Room Terminal 11: Heating Circuit 1 Room Terminal 12: Heating Circuit 2 Room Terminal 13: Heating Circuit 3 Room Terminal 14: Heating Circuit 4 Room Terminal 15: Heating Circuit 5 Room Terminal 16: Heating Circuit 6 Room Terminal
Temperature Probe	No Yes	-	No: Temperature probe is not in alarm. Yes: Temperature probe has active alarm. Contact Your installation company, pAD must be replaced.
Humidity Probe	No Yes	-	No: Humidity probe is not in alarm. Yes: Humidity probe has active alarm. Contact Your installation company, pAD must be replaced.
Unit Offline	No Yes	-	No: Unit is Online, no alarm. Yes: Unit is Offline = alarm Please check proper pAD location in the plastic frame on the wall. If the position is correct, please contact installation company.
pAD Active	No Yes	-	pAD xx Status (Yes=active).

10.3.9 pAD related supervisor parameters

Supervisor Parameters Table

Parameter:	pAD01	pAD11	pAD12	pAD13	pAD14	pAD15	pAD16
Active	B242	B245	B248	B251	B254	B257	B259
On/Off	I16	I15	I6	I227	I230	I239	I210
Mode	I181	I218	I217	I228	I237	I240	I248
Setpoint	A191	A219	A225	A231	A238	A247	A256
Temperature	A190	A220	A226	A232	A239	A248	A257
Humidity	I185	I219	I220	I229	I238	I247	I249
Setpoint Sleep	A263	A264	A267	A270	A273	A276	A277
pAD Enabled	B182	B244	B247	B250	B253	B256	B258
Hyster. Heat	A194	A265	A268	A271	A274	A431	A278
Hyster. Cool	A195	A266	A269	A272	A275	A432	A279
Alarm Temperature Probe	B198	-	-	-	-	-	-
Alarm Humidity Probe	B199	-	-	-	-	-	-

10.4 Configuration

Basic and HW configuration of heat pump system.

10.4.1

```

Configuration
Heat Pump Type
Air/Water
1 Compressor
1 Refrigerant Circuit
Mini
MasterLan: No
    
```

Parameter:	SP	Range/F.:	Unit	Description
HP type	I14	0: A/W 1: B/W 2: W/W 3: DX/W 4: A/W R 5: B/W R 6: W/W R	-	Type of the heat pump system.
Compressors	B40	0: 1 Comp 1: 2 Comp	-	Single or Double compressor unit.
Ref. Circuit	B39	0: 1 RC 1: 2 RC	-	1 or 2 refrigerant circuits present.
Mini/Aku	I208	0: Mini 1: Mini SHW 2: Aku	-	Hydraulic type of the unit. Mini = standard unit, Mini SHW = unit with external storage tank with fresh SHW heat exchanger, Aku = internal storage tank .
MasterLan	-	0: No 1: Yes	-	MasterLan Master/Slave system.

10.4.2 Timing

```

Configuration
PUMP Circulation Time
0060 s

Compressor Off Time
0360 s
    
```

Parameter:	SP	Range/F.:	Unit	Description
Pump Circulation Time	I8	0-9999 F: 60	s	Pump circulation time after compressor Off cycle, the water temperature is measured and compared to setpoint.
Compressor Off Time	I7	0-9999 F: 360	s	Minimum compressor Off time, between On cycles or alarm recovery time. Never set lower than 120s for service purposes.

10.4.3 Double compressor unit setup

```

Configuration
Compressors Rotation
Disabled
2nd Compressor Delay
0000 s
  
```

Parameter:	SP	Range/F.:	Unit	Description
Rotation	B206	0: Disabled 1: Enabled F: 1	-	Enables or Disables 2 compressors rotation.
2nd Compressor Delay	I209	0-9999 F: 15	s	Delay of the 2nd compressor start after starting the 1st one.

10.4.4 Pump Timing

```

Configuration
PUMP Before Compressor
0030 s
PUMP After Compressor
0030 s
  
```

Parameter:	SP	Range/F.:	Unit	Description
Pump Before Compressor	I9	0-9999 F: 30	s	Pump start time before compressor start.
Pump After Compressor	I10	0-9999 F: 30	s	Pump stop time after compressor stop.

10.4.5 Remote On/Off (Tariff) configuration

```

Configuration
Remote On/Off (Tariff)
Compressor:
Enabled
Aux.Heater:
Enabled
Sanitary Hot Water:
Disabled
    
```

Parameter:	SP	Range/F.:	Unit	Description
Compressor	B75	0: Disabled 1: Enabled	-	When Enabled, compressor starts and stops according to remote on/off input.
Aux. Heater	B74	0: Disabled 1: Enabled	-	When Enabled, auxiliary heater starts and stops according to remote on/off input.
Sanitary Hot Water	B76	0: Disabled 1: Enabled	-	When Disabled, compressor starts and stops to heat sanitary hot water, ignoring remote on/off input.

10.4.6 SHW/H&C timing

```

Configuration
Max Time SHW Mode:
060 min
Min Time H/C Mode:
060 min
    
```

Parameter:	SP	Range/F.:	Unit	Description
Max Time SHW Mode	I53	0-999 F: 60	min	Maximum time the unit stays in SHW mode.
Min Time H/C Mode	I54	0-999 F: 60	min	Minimum time the unit stays in H/C mode before returns to SHW or Pool mode.

10.4.7 Compressor 1 Statistics

```

Configuration
Hours Compressor 1
Total: 000000 Hrs
Starts: 00000 x10
Service: 000000 Hrs
Total Reset: 0
Service Reset: 0
    
```

Parameter:	SP	Range/F.:	Unit	Description
Hours Compressor 1 Total	-	0-999999	hrs	Total compressor operating time.
Compressor 1 Starts	112	0-32000 x10	-	Total compressor starts
Service	111	0-32000	Hrs	Service compressor operating hours. Operating hours from last service reset.
Total Reset	-	0/1	-	Change to 1 for reset of the total operating hours.
Service Reset	-	0/1	-	Change to 1 for reset of the service operating hours.

10.4.8 Compressor 2 Statistics

```

Configuration
Hours Compressor 2
Total: 000000 Hrs
Starts: 00000 x10

Service: 000000 Hrs
Total Reset: 0
Service Reset: 0
  
```

Parameter:	SP	Range/F.:	Unit	Description
Hours Compressor 2 Total	-	0-999999	hrs	Total compressor 2 operating time.
Compressor 2 Starts	-	0-32000 x10	-	Total compressor 2 starts
Service	-	0-32000	Hrs	Service compressor 2 operating hours. Operating hours from last service reset.
Total Reset	-	0/1	-	Change to 1 for reset of the total operating hours.
Service Reset	-	0/1	-	Change to 1 for reset of the service operating hours.

10.4.9 Service Time / Fan Time

```

Configuration
Comp. Service Time
003000 Hrs

Hours Fan
Total: 000000 Hrs

Total Reset: 0
  
```

Parameter:	SP	Range/F.:	Unit	Description
Service Time	-	0-999999	hrs	Compressor service period.
Hours Fan	-	0-999999	hrs	Fan operating hours.
Total Reset	-	0/1	-	Change to 1 for reset of the fan operating hours.

10.4.10 Pump Time

```

Configuration
Hours Pump
Total: 000000 Hrs

Total Reset: 0
  
```

Parameter:	SP	Range/F.:	Unit	Description
Hours Pump	I13	0-999999	hrs	Pump operating hours.
Total Reset	-	0/1	-	Change to 1 for pump operating hours reset.

10.4.11 Heater Statistics

```

Configuration
Hours Heater 1
Total: 000000 Hrs
Hours Heater 2
Total: 000000 Hrs

Total Reset: 0
  
```

Parameter:	SP	Range/F.:	Unit	Description
Hours Heater 1 Total	I100	0-999999	hrs	Total heater 1 operating time.
Hours Heater 2 Total	I101	0-999999	hrs	Total heater 2 operating time.
Total Reset	-	0/1	-	Change to 1 for heaters operating hours reset.

10.4.12 Heat Pump ID / SW Release

```

Configuration
Heat Pump ID:
00001

SW Release:
PCO5_001
  
```

Parameter:	SP	Range/F.:	Unit	Description
ID	172	0-32000 F: 1	-	Heat Pump ID
SW Release	1104	0-999	-	pCO5 SW Release.

10.4.13 Probes Selection

```

Configuration I/O
Control Probe:
B2/pCO5
Antifreeze Probe:
B2/pCO5
Outdoor Probe:
B3/pCO5
  
```

Parameter:	SP	Range/F.:	Unit	Description
Control Probe	-	B1-B5/pCO5 B1-B4/pCOe F: B2/pCO5	-	Water control probe selection.
Antifreeze Probe	-	B1-B5/pCO5 B1-B4/pCOe F: B2/pCO5	-	Antifreeze control probe selection.
Outdoor Probe	-	B1-B5/pCO5 B1-B4/pCOe F: B2/pCO5	-	Outdoor control probe selection.

10.4.14 ID Configuration 1

```

Configuration I/O
Safety Thermostat:
ID1_pCO5
High Pressure Switch:
ID2_pCO5
Compressor 1 Thermal:
ID3_pCO5
    
```

Parameter:	SP	Range/F.:	Unit	Description
Safety Thermostat	-	ID1-ID8_pCO5 F: ID1_pCO5	-	Heater safety thermostat input.
High Pressure Switch	-	ID1-ID8_pCO5 F: ID2_pCO5	-	High pressure switch input.
Compressor 1 Thermal	-	ID1-ID8_pCO5 F: ID3_pCO5	-	Compressor 1 thermal protection input.

10.4.15 ID Configuration 2

```

Configuration I/O
Remote On/Off(Tariff):
ID4_pCO5
Fan Thermal:
ID5_pCO5
Flow Switch:
ID6_pCO5
    
```

Parameter:	SP	Range/F.:	Unit	Description
Remote On/Off	-	ID1-ID8_pCO5 F: ID4_pCO5	-	Remote On/Off input.
Fan Thermal	-	ID1-ID8_pCO5 F: ID5_pCO5	-	Fan thermal protection input.
Flow Switch	-	ID1-ID8_pCO5 F: ID6_pCO5	-	Flow switch protection input.

10.4.16 ID Configuration 3

```

Configuration I/O
Compressor 2 Thermal:
Not Used
HP Switch Circuit 2:
Not Used
Remote Heat/Cool:
Not Used
    
```

Parameter:	SP	Range/F.:	Unit	Description
Compressor 2 Thermal	-	ID1-ID8_pCO5 F: Not Used	-	Compressor 2 thermal protection input.
HP Switch Circuit 2	-	ID1-ID8_pCO5 F: Not Used	-	High pressure switch of the 2nd refrigeration circuit.
Remote Heat/Cool	-	ID1-ID8_pCO5 F: Not Used	-	Input for function remote control Heating/Cooling.

10.4.17 Relay Configuration 1

```

Configuration I/O
Compressor Relay:
Relay 1 /pCO5

Compressor 2 Relay:
Not Used
  
```

Parameter:	SP	Range/F.:	Unit	Description
Compressor Relay	-	R1-R8/pCO5 F: R1/pCO5	-	Compressor output relay.
Compressor 2 Relay	-	R1-R8/pCO5 F: Not Used	-	Compressor 2 output relay.

10.4.18 Relay Configuration 2

```

Configuration I/O
Reversing Valve:
Relay 2 /pCO5
Alarm Relay:
Not Used
Alarm Relay Polarity:
Open
  
```

Parameter:	SP	Range/F.:	Unit	Description
Reversing Valve	-	R1-R8/pCO5 F: R2/pCO5	-	Reversing valve output relay.
Alarm Relay	-	R1-R8/pCO5 F: Not Used	-	Alarm relay output.
Alarm Relay Polarity	-	Open Closed	-	Alarm relay output polarity when alarm is active.

10.4.19 Relay Configuration 3

```

Configuration 1/0
Auxiliary Heater 1:
Relay 4 /pCO5

Auxiliary Heater 2:
Relay 5 /pCO5
  
```

Parameter:	SP	Range/F.:	Unit	Description
Auxiliary Heater 1	-	R1-R8/pCO5 F: R4/pCO5	-	Heater 1 relay output.
Auxiliary Heater 2	-	R1-R8/pCO5 F: R5/pCO5	-	Heater 2 relay output.

10.4.20 Relay Configuration 4

```

Configuration 1/0
Heating/Cooling Relay:
Not Used

H/C Relay Polarity:
Cooling = On
  
```

Parameter:	SP	Range/F.:	Unit	Description
Heating/Cooling Relay	-	R1-R8/pCO5 F: Not Used	-	Heating / Cooling function relay output.
H/C Relay Polarity	-	Cooling = On Cooling = OFF	-	H/C relay output polarity.

10.4.21 Analog Output Configuration

```

Configuration I/O
Analog Outputs
Y1/pCO5: HC 1
Y2/pCO5: HC 2
Y3/pCO5: Fan
Y4/pCO5: Pump
Y1/pCOe: HC 3
Key PRG for AO Setup
  
```

Parameter:	SP	Range/F.:	Unit	Description
Y1/pCO5	-	HC1-HC6 Fan Pump Solar F: HC1	-	Configuration of analog output Y1(0-10V).
Y2/pCO5	-	HC1-HC6 Fan Pump Solar F: HC2	-	Configuration of analog output Y2(0-10V).
Y3/pCO5	-	HC1-HC6 Fan Pump Solar F: Fan	-	Configuration of analog output Y3(PWM).
Y4/pCO5	-	HC1-HC6 Fan Pump Solar F: Pump	-	Configuration of analog output Y4(PWM).
Y1/pCOe	-	HC1-HC6 Fan Pump Solar F: HC3	-	Configuration of analog output Y1/pCOe(0-10V).

10.5 Pump Set

Hot side pump setting.

10.5.1 Pump Timing

```

Load Side Pump
PUMP Before Compressor
0030 s
PUMP After Compressor
0030 s
PUMP Run Type
COMPRESSOR
  
```

Parameter:	SP	Range/F.:	Unit	Description
Pump Before Compressor	I9	0-9999 F: 30	s	Pump start time before compressor start.
Pump After Compressor	I10	0-9999 F: 30	s	Pump stop time after compressor stop.
Pump Run Type	B1	0: Compressor 1: Permanent F: Compressor	-	Type of the pump run. When Compressor, it runs only with compressor, with periodical circulation "Pump Circulation Time" after each "Compressor Off Time". When "Pump Circulation Time" set to 0, pump runs with compressor only (see 10.4.2). When set to Permanent, pump runs except the "Summer Mode".

10.5.2 Pump Speed Heating

```

Load Side Pump
Heating Mode
Minimum Speed:050.0 %
Maximum Speed:100.0 %
  
```

Parameter:	SP	Range/F.:	Unit	Description
Minimum Speed	A157	0-100 F: 50.0	%	Minimum pump speed for minimum inverter speed.
Maximum Speed	A158	0-100 F: 100.0	%	Maximum pump speed for maximum inverter speed.

10.5.3 Pump dT Mode (Reserved for future use)

10.5.4 Pump Speed Cooling

```

Load Side Pump
Cooling Mode
Minimum Speed: 050.0 %
Maximum Speed: 100.0 %
    
```

Parameter:	SP	Range/F.:	Unit	Description
Minimum Speed	A496	0-100 F: 50.0	%	Minimum pump speed for minimum inverter speed.
Maximum Speed	A497	0-100 F: 100.0	%	Maximum pump speed for maximum inverter speed.

10.5.5 Pump Antifreeze Function

```

Load Side Pump
Antifreeze Function
Water Temp: 20.0 °C
Air Temp: -20.0 °C
    
```

Parameter:	SP	Range/F.:	Unit	Description
Water Temp	A498	-99.9/99.9 F: 20.0	°C	Water temperature to start pump like antifreeze function.
Air Temp	A201	-99.9/99.9 F: -20.0	°C	Outdoor air temperature to start pump like antifreeze function.

10.5.6 Pump Flow Alarm

```

Load Side Pump
Pump Alarm: Disabled
Alarm On Time: 0010 s
Pump Alarm Active: No
    
```

Parameter:	SP	Range/F.:	Unit	Description
Pump Alarm	B31	0: Disabled 1: Enabled	-	Function Stops pump when no flow after "Alarm On Time" from pump start. Pump symbol flashes on the main screen. It tries to restart the pump after "Compressor Off Time".
Alarm On Time	I55	0-9999 F: 10	s	Pump alarm time delay.
Pump Alarm Active	B385	0: No 1: Yes	-	When Yes, pump alarm is actually active. Pump symbol flashes on the main screen.

10.5.7 Pump HW config

```

Load Side Pump [X]
PUMP Relay:
Relay 3 /pCO5
PUMP Analog Out:
Use "Configuration"
PUMP Manual: 000.0 %
  
```

Parameter:	SP	Range/F.:	Unit	Description
Pump Relay	-	R1-R8/pCO5 F: R3/pCO5	-	Pump relay output configuration.
Pump Manual	A499	0-100.0 F: 000.0	%	Manual Pump activation (Permanent memory). When set higher than 1.0%, the relay and analog outputs are activated. Must be set to 0 for automatic operation.

10.6 Fan (Brine Pump) Set

Fan or brine pump configuration.

10.6.1 Fan Timing

```

Fan / Brine Pump
Fan before Compressor
015 s
Fan After Compressor
015 s
  
```

Parameter:	SP	Range/F.:	Unit	Description
Fan before Compressor	I30	0-999 F: 15	s	Fan/Brine Pump start before compressor start.
Fan after Compressor	I31	0-999 F: 15	s	Fan/Brine Pump stop after compressor stop.

10.6.2 Fan Speed Heating Mode

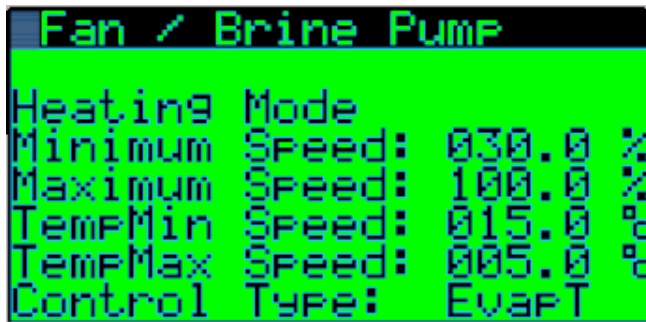

```

Fan / Brine Pump
Heating Mode
Minimum Speed: 030.0 %
Maximum Speed: 100.0 %
TempMin Speed: 015.0 %
TempMax Speed: 005.0 %
Control Type: EvapT
  
```

Parameter:	SP	Range/F.:	Unit	Description
Minimum Speed	A56	0-100 F: *	%	Minimum fan/brine pump speed for minimum inverter speed.
Maximum Speed	A58	0-100 F: *	%	Maximum fan/brine pump speed for maximum inverter speed.
TempMin Speed	A446	-99.9-99.9 F: 15.0	°C	Evaporating temperature for fan/brine pump minimum speed in EvapT control mode
TempMax Speed	A447	-99.9-99.9 F: 5.0	°C	Evaporating temperature for fan/brine pump maximum speed in EvapT control mode
Control Type	D439	Speed(0) EvapT(1) F: 0	-	0=fan/brine pump speed related to compressor speed 1=fan/brine pump speed related to evaporating temperature

*Factory setting:

Unit type	Minimum Speed %	Maximum Speed %
AM, EM, AQ	100	100
AM, EM with DC Fan	50	50
EM60Z, EM75Z with DC Fan	75	75
BA	70	70
AQxxl	50	100
BA22I, BA30I	30	70
BA45I	50	90-100

10.6.3 Fan Speed Cooling Mode

```

Fan / Brine Pump
Cooling Mode
Minimum Speed: 030.0 %
Maximum Speed: 100.0 %
Temp.MinSpeed:030.0 °C
Temp.MaxSpeed:040.0 °C
  
```

Parameter:	SP	Range/F.:	Unit	Description
Minimum Speed	A60	0-100 F: *	%	Minimum fan/brine pump speed for minimum speed condensing temperature.
Maximum Speed	A62	0-100 F: *	%	Maximum fan/brine pump speed for maximum speed condensing temperature.
Temperature Min. Speed	A61	-99.9 - 99.9 F: 30.0	°C	Temperature for minimum speed.
Temperature Max. Speed	A63	-99.9 - 99.9 F: 40.0	°C	Temperature for Maximum speed.

*Factory setting:

Unit type	Minimum Speed %	Maximum Speed %
AM, EM, AQ	100	100
AM, EM with DC Fan	20	60
EM60Z, EM75Z with DC Fan	20	100
BA	30	70
AQxxl	30	100
BA22I, BA30I	30	70
BA45I	30	100

10.6.4 Fan On/Off Cooling Mode

```

Fan / Brine Pump
Cooling Mode
Temp. Fan On: 025.0 °C
Temp. Fan Off: 020.0 °C
Defrost Manual Mode
Temp. Fan On: 050.0 °C
    
```

Parameter:	SP	Range/F.:	Unit	Description
Temperature Fan On	A65	-99.9 - 99.9 F: 25.0	°C	Fan/Brine pump start temperature in cooling mode.
Temperature Fan Off	A64	-99.9 - 99.9 F: 20.0	°C	Fan/Brine pump stop temperature in cooling mode.
Defrost Manual Mode Temp.Fan On	A493	-99.9 - 99.9 F: 50.0	°C	Fan/Brine pump start temperature in manual defrost mode.

10.6.5 Fan PID setting Cooling Mode

```

Fan / Brine Pump
Cooling Mode
P Band: 050.0 %
I Time: 100 s
D Time: 020 s
Period: 1000 ms
    
```

Parameter:	SP	Range/F.:	Unit	Description
P Band	A494	0 - 999.9 F: 50.0	°C	Fan/Brine pump speed control Proportional Band in Cooling/Passive cooling mode.
I Time	I78	0 - 999 F: 100	s	Integration Time for speed control in Cooling/Passive cooling mode.
D Time	I76	0 - 999 F: 20	s	Derivative Time for speed control on Cooling/Passive cooling mode.
Period	-	0-9999 F: 1000	ms	PID control period. Do not set below 1000ms.

10.6.6 Fan - Winter Periodic Run

```

Fan / Brine Pump
Winter Periodic Run
Enabled:          No
Start Temp:      02 %
On Period:       0000 s
Off Period:      0360 s
Output:          No
Fan/Speed:      No /000.0%
  
```

Parameter:	SP	Range/F.:	Unit	Description
Enabled	-	0 – No 1- Yes F: No	-	Periodic Run Enabled.
Start Temp:	-	-99/99 F: 2	°C	Requested temperature for switching in winter period.
On Period	-	0 - 9999 F: 0	s	Runtime in winter period.
Off Period	-	0-9999 F: 360	s	Off time between running time.
Output	-	Yes/No	-	Output status.
Fan/Speed	-	Yes/No 0-100.0	-%	Fan status. Yes= ON Speed displayed.

10.6.7 Fan I/O Configuration

```

Fan / Brine Pump I/O
Fan Relay:
Not Used
Fan Analog Out:
Use "Configuration"
Fan Manual: 000.0 %
  
```

Parameter:	SP	Range/F.:	Unit	Description
Fan Relay	-	R1-R8/pCO ₅ F: Not Used	-	Fan relay output configuration. Normally Analog Output only is used.
Fan Analog Out	-	-	-	Please see menu "Configuration" for Analog Output assignment.
Fan Manual	A11	0-100.0 F: 000.0	%	Manual Fan activation (Permanent memory). When set higher than 1.0%, the relay and analog outputs are activated. Must be set to 0 for automatic operation.

10.7 Alarms Set

Setting of general alarms parameters.

10.7.1 Antifreeze Alarm

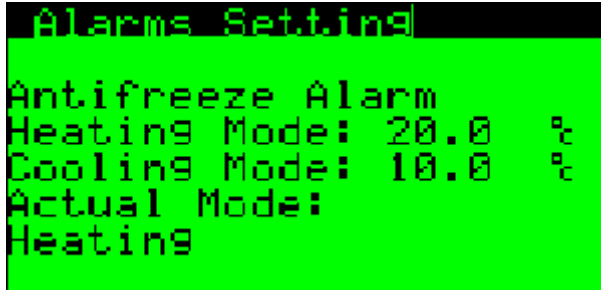

Parameter:	SP	Range/F.:	Unit	Description
Heating Mode	A52	-999 - 999 F: *	°C	Heating water antifreeze setpoint in "Heating" antifreeze mode.
Cooling Mode	A150	-999 - 999 F: *	°C	Heating water antifreeze setpoint in "Cooling" antifreeze mode.
Actual Mode	-	Heating/Cooling	-	Actual antifreeze mode: "Heating" = Outdoor temperature below defrost limit. "Cooling" = Outdoor temperature above defrost limit.

*Factory setting:

Unit type	Heating Mode °C	Cooling Mode °C
AM, EM	20	10
AM, EM glycol 15%	15	10
AQ	10	10
BA, glycol min. 30%	5	5

10.7.2 Low Pressure Alarm

```

Alarms Setting
Low Pressure Alarm
Setpoint: 00.7 bar
Hysteresis: 00.5 bar

Alarm Delay: 005 s
  
```

Parameter:	SP	Range/F.:	Unit	Description
Low Pressure Alarm Setpoint	A76	-99.9 - 99.9 F: *	bar	Low Pressure alarm setpoint. (Electronic pressure switch).
Hysteresis	A125	-99.9 - 99.9 F: 0.5	bar	Low pressure alarm hysteresis. Alarm disappears when real pressure > setpoint + hysteresis
Low Pressure Alarm Delay	I18	0-999 F:*	s	Low pressure alarm delay activation.

*Factory setting:

Unit type	LP Setpoint, bar	LP Delay, s
407c units, AM, EM, BA	0.6	120
407c units, AQ	1.7	5
410a units, BA	1.5	120
410a units, AQ	4.0	5

10.7.3 High Pressure Alarm

```

Alarms Setting
High Pressure Alarm
Setpoint: 28.0 bar
Hysteresis: 05.0 bar
Low Pressure HP Side
Setpoint: 02.0 bar
  
```

Parameter:	SP	Range/F.:	Unit	Description
High Pressure Alarm Setpoint	A74	-99.9 - 99.9 F: *	bar	High Pressure alarm setpoint. (Electronic pressure switch).
Hysteresis	A492	-99.9 - 99.9 F: 5.0	bar	High pressure alarm hysteresis. Alarm disappears when real pressure < setpoint - hysteresis
Low Pressure Alarm on high pressure side Setpoint	A75	-99.9 - 99.9 F: *	bar	Low Pressure alarm setpoint on high pressure side. (Electronic pressure switch). Alarm avoids compressor running when low amount of refrigerant in the circuit.

Unit type	HP Setpoint, bar	LP HP side, bar
407c units	28.0	1.0
410a units	41.0	2.0

10.7.4 Low Evaporating Temperature

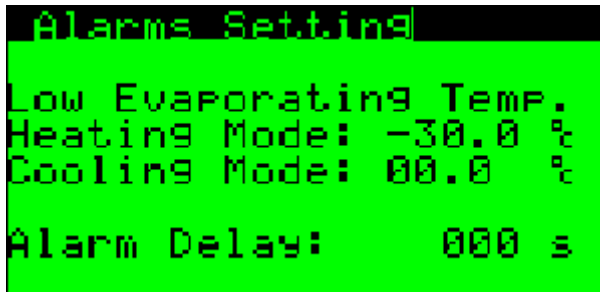

Parameter:	SP	Range/F.:	Unit	Description
Low Evaporating Heating Mode	A54	-99.9 - 99.9 F: *	°C	Low evaporating temperature protection for heating mode. When evaporating temperature, calculated from suction pressure drops below threshold, alarm is activated after alarm delay.
Low Evaporating Cooling Mode	A128	-99.9 - 99.9 F: *	°C	The same protection as above in cooling mode.
Low Evaporating Alarm Delay	I319	0-999 F: 5	s	Low evaporating temperature alarm delay.

*Factory setting:

Unit type	LE Heating Mode °C	LE Cooling Mode °C
AM, EM	-35.0	0.0
AM, EM glycol 15%	-35.0	-5.0
AQ, ground loop BW	-15.0	1.0
AQ, open loop WW	1.0	1.0
BA, glycol min. 15%	-35.0	-5.0
BA, glycol min. 30%	-35.0	-15.0

10.7.5 High Condensing Temperature

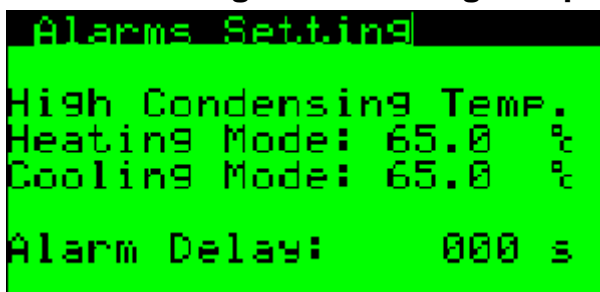

Parameter:	SP	Range/F.:	Unit	Description
High Condensing Heating Mode	A53	-99.9 - 99.9 F: 68.0	°C	High condensing temperature protection for heating mode. Value is calculated from discharge pressure. Alarm is activated after alarm delay.
High Condensing Cooling Mode	A127	-99.9 - 99.9 F: 65.0	°C	The same protection as above in cooling mode.
High Condensing Alarm Delay	I320	0-999 F: 5	s	Alarm Delay before High Condensing Temperature.

10.7.6 High Compressor Discharge Temperature

```

Alarms Setting
High Discharge Temp.
Setpoint: 120.0 °C
Flow Switch Delay:
                005 s
Alarm Relay Type:
Some Error
  
```

Parameter:	SP	Range/F.:	Unit	Description
High Discharge Gas Temperature Setpoint	A55	-999 - 999 F:	°C	Compressor protection avoiding too high discharge temperature of refrigerant.

*Factory setting:

Unit type	High DGT °C
AM, EM, BA, AQ	130.0
AQ22I, AQ30I, BA22I, BA30I	115.0
AQ45I, BA45I	110.0

10.7.7 Flow Switch Delay

Parameter:	SP	Range/F.:	Unit	Description
Flow Switch Delay	I17	0 - 999 F: 5	s	Bypassing flow switch time after pump/submersible pump start.

10.7.8 Alarm Relay Type

Parameter:	SP	Range/F.:	Unit	Description
Alarm Relay Type	B384	0/1 F: 0	-	Specifies type of alarm relay activation. 0=Some Error - relay activated when alarm is active. 1=Manual Reset Required - relay activated when unit requires manual reset of alarm (3 alarms condition).

10.8 Defrost Set

Setting of defrost parameters.

10.8.1 Defrost Point A

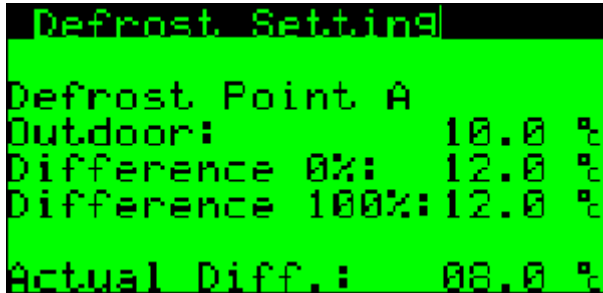

```

Defrost Setting
Defrost Point A
Outdoor: 10.0 °C
Difference 0%: 12.0 °C
Difference 100%: 12.0 °C
Actual Diff.: 08.0 °C
  
```

Parameter:	SP	Range/F.:	Unit	Description
Defrost Point A Outdoor Temp.	A66	-99.9 - 99.9 F: *	°C	Outdoor reference temperature for difference definition of the point A.
Defrost A Difference 0%	A68	-99.9 - 99.9 F: *	°C	Difference (Outdoor - Evaporating Temperature) to start defrost for minimum compressor capacity.
Defrost A Difference 100%	A57	-99.9 - 99.9 F: *	°C	Difference (Outdoor - Evaporating Temperature) to start defrost for maximum compressor capacity.
Actual Difference A	-	-99.9 - 99.9	°C	Real actual calculated difference, point A.

10.8.2 Defrost Point B

```

Defrost Setting
Defrost Point B
Outdoor:          -10.0 °C
Difference 0%:    08.0 °C
Difference 100%: 08.0 °C
Activation Delay: 060s
Actual Diff.:    08.0 °C
  
```

Parameter:	SP	Range/F.:	Unit	Description
Defrost Point B Outdoor Temp.	A67	-99.9 - 99.9 F: *	°C	Outdoor reference temperature for difference definition of the point B.
Defrost B Difference 0%	A69	-99.9 - 99.9 F: *	°C	Difference (Outdoor - Evaporating Temperature) to start defrost for minimum compressor capacity.
Defrost B Difference 100%	A59	-99.9 - 99.9 F: *	°C	Difference (Outdoor - Evaporating Temperature) to start defrost for maximum compressor capacity.
Actual Difference B	-	-99.9 - 99.9	°C	Real actual calculated difference, point B.
Activation Delay	I45	0-999 F: 60	s	Defrost activation delay. When temperature difference is reached for at least Activation Delay, defrost starts.

10.8.3 Forced Defrost Set

Forced defrost bypasses minimum time between defrost cycles. When temperature difference between outdoor and evaporating temperature is too high, defrost starts after forced defrost delay.

```

Defrost Setting
Forced Def. Difference
Outdoor +10% : 15.0 °C
Outdoor -20% : 10.0 °C
Forced Delay: 0360 s
Actual Diff.: 10.0 °C
  
```

Parameter:	SP	Range/F.:	Unit	Description
Forced Difference Outdoor +10°C	A72	-99.9 - 99.9 F: 15.0	°C	Difference (Outdoor - Evaporating Temperature) to start forced defrost for outdoor temperature +10°C.
Forced Difference Outdoor -20°C	A22	-99.9 - 99.9 F: 10.0	°C	Difference (Outdoor - Evaporating Temperature) to start forced defrost for outdoor temperature -20°C.
Forced Delay	I38	0-9999 F: 360	s	Forced Defrost activation delay. When temperature difference is reached for at least Activation Delay, defrost starts.
Actual Difference	A23	-99.9 - 99.9	°C	Real actual calculated difference, to start forced defrost.

10.8.4 Defrost Limit, End, Heater activation Temperature

```

Defrost Setting
Enabled below
Outdoor Temp.: 12.0 °C
Defrost End
Temperature: 35.0 °C
Heater
Activation: 30.0 °C
  
```

Parameter:	SP	Range/F.:	Unit	Description
Enabled below Outdoor Temperature	A70	-99.9 - 99.9 F: *	°C	Outdoor temperature threshold, below defrost operation is enabled.
Defrost End Temperature	A71	-99.9 - 99.9 F: *	°C	Defrost end temperature. When condensing temperature reaches defrost end temperature, defrost stops.
Heater Activation	A73	-99.9 - 99.9 F: 30.0	°C	When in defrost mode water temperature drops below Heater Activation - Heater Hysterezis, heater is activated to keep water temperature sufficient to perform defrost.

10.8.5 Defrost Timing 1

```

Defrost Setting
Min. Time between
2 Cycles: 060min
RU & Compressor
Delay Start: 030 s
Delay End: 060 s
PT Swap Delay: 040 s
  
```

Parameter:	SP	Range/F.:	Unit	Description
Minimum Time between 2 Cycles	I32	0-999 F: *	min	Minimum time between 2 defrost cycles. This time from last defrost cycle must be elapsed before starting next defrost cycle, with exception of Forced Defrost.
RV&Compressor Delay Start	I34	0-999 F: *	s	Reversing valve and compressor delay when starting defrost cycle. When defrost cycle is activated, compressor stops. After this delay reversing valve changes position following additional the same delay, before compressor is started in defrost mode.
Delay End	I323	0-999 F: *	s	Compressor OFF period after finishing the defrost cycle. When set to 0, compressor will not stop.
PT Swap Delay	I324	0-999 F: 60	s	Delay to swap pressure transducers between suction line (detects defrost start) and discharge line (detects defrost end) after compressor stops before defrost cycle.

10.8.6 Defrost Timing 2

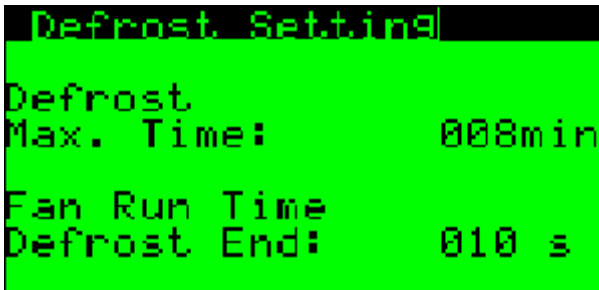

```

Defrost Setting
Defrost
Max. Time:      008min
Fan Run Time
Defrost End:    010 s
  
```

Parameter:	SP	Range/F.:	Unit	Description
Defrost Maximum Time	I33	0-999 F: *	min	Maximum duration of defrost cycle. If defrost end temperature is not reached in this time, defrost stops.
Fan Run Time Defrost End	I102	0-999 F: *	s	When defrost end temperature is reached, fan starts for this time to reduce discharge pressure and 4 way valve changes position for heating mode.

10.8.7 Hot Water at Defrost

```

Defrost Setting
Sanitary Hot Water
Deactivation: Yes

Manual Defrost
Time: 015 min
Fan On Temp: 50.0 °C
  
```

Parameter:	SP	Range/F.:	Unit	Description
Sanitary Hot Water Deactivation	B44	Yes/No F: Yes	-	When set to "Yes", Hot water is deactivated during defrost mode. We recommend to keep this setting for Hot Water Tank with heat exchanger and 3 way valve combination. For "Tank in Tank" we recommend setting "No".
Manual Defrost Time			min	Reserved for future use.
Fan On Temperature			°C	Reserved for future use.

10.8.8 Defrost Info

```

Defrost Setting
Time from Last: 000min
Temperature
Condition: No
Start Manual: No
  
```

Parameter:	SP	Range/F.:	Unit	Description
Time from Last	I35	0-200	min	Time elapsed from last defrost cycle.
Temperature Condition	-	Yes/No	-	Informs if temperature difference for starting the defrost cycle is met.
Start Manual	B386	Yes/No	-	When set to "Yes" and temperature condition is met, defrost starts immediately. After 5 seconds, the parameter returns to "No".

10.8.9 Defrost Factory Setting

Parameter	unit	SP	AM EM ≤-30	AM EM >30	AM IS EM IS	BA	BA I
Defrost Point A Outdoor Temp.	°C	A66	10.0	10.0	10.0	10.0	10.0
Defrost A Difference 0%	°C	A68	12.0	12.0	14.0	12.0	12.0
Defrost A Difference 100%	°C	A57	12.0	12.0	14.0	12.0	12.0
Defrost Point B Outdoor Temp.	°C	A67	-10.0	-10.0	-10.0	-10.0	-10.0
Defrost B Difference 0%	°C	A69	0.0	8.0	8.0	0.0	3.0
Defrost B Difference 100%	°C	A59	0.0	8.0	8.0	0.0	8.0
Activation Delay	s	I45	60	60	60	60	60
Forced Difference Outdoor +10°C	°C	A72	15.0	15.0	18.0	15.0	15.0
Forced Difference Outdoor -20°C	°C	A22	10.0	10.0	10.0	10.0	10.0
Forced Delay	s	I38	360	360	360	360	360
Enabled below Outdoor Temperature	°C	A70	12.0	12.0	15.0	12.0	12.0
Defrost End Temperature	°C	A71	35.0	35.0	50.0	45.0	45.0
Heater Activation	°C	A73	30.0	30.0	30.0	30.0	30.0
Minimum Time between 2 Cycles	min	I32	60	60	45	45	45
RV&Compressor Delay Start	s	I34	30	30	30	30	30
Delay End	s	I323	0	0	0	0	60
PT Swap Delay	s	I324	60	60	60	60	60
Defrost Maximum Time	min	I33	15	15	8	8	8
Fan Run Time Defrost End	s	I102	10	10	10	10	10
Sanitary Hot Water Deactivation	-	B44	1	1	1	1	1

10.9 Expansion Set

Setting of Electronic Expansion Valve parameters.

10.9.1 Expansion info

```

EExpansion Info
StSht/DSht:06.0 /00.5
PV:0000      Power:005%
LP/HP:00.0  /00.0  bar
ET/CT:00.0  / 00.0  °C
S/DGT:00.0  /000.0  °C
S/Dht:00.0  /000.0  °C
Mode: DSht  Auto
  
```

Parameter:	Range/F.:	Unit	Description
StSht	-99.9 99.9	°C	Suction Superheat Setpoint.
StDSht	-99.9 99.9	°C	Discharge Superheat Setpoint.
PV	0 9999	-	Actual valve position.
Power	0 100	%	Requested valve capacity.
LP/HP	-1.0 45.0	bar	Actual Compressor Suction / Discharge Pressure.
ET/CT	-50.0 99.9	°C	Actual Evaporating/Condensing Temperature.
S/DGT	-50.0 150.0	°C	Actual Suction / Discharge Gas Temperature.
S/Dht	-50.0 99.9	°C	Actual Suction / Discharge Superheat.
Mod	SSht DSht	°C	Actual Control type. SSht: Suction Superheat Control DSht: Discharge Superheat Control

10.9.2 Config

```

Expansion Setting
Compressor: GKT141DBA
E2V Heating: E2V14
E2V Cooling: E2V14
Refrigerant: R407c
Cap.Offset: 020.0 %
Comp. Delay: 001 s
Glider Time: 060 s
    
```

Parameter:	SP	Range/F.:	Unit	Description
Compressor	I300	0-19	-	Compressor model used in the unit. 0=GKT141, 1=GJT240, 2=GPT425DBA, 3=GPT425DAA, 4=AQ036, 5=C-SBN26x, 6=C-SBN30x, 7=C-SBN37x, 8=C-SBN453, 9=C-SBS235, 10=C-SCN603, 11=C-SCN753, 12=C-SCN903, 13=ZH15, 14=ZH21, 15=ZH30, 16=ZH38, 17=ZH45, 18=JBA068, 19=GJT325
E2V Heating	I301	0-7	-	Size of valve Carel E2V used in heating mode. 0=14, 1=18, 2=24, 3=30, 4=35, 5=45, 6=55, 7=65
E2V Cooling	I302	0-7	-	Size of valve Carel E2V used in cooling mode. 0=14, 1=18, 2=24, 3=30, 4=35, 5=45, 6=55, 7=65
Refrigerant	I303	0-1	-	Type of used refrigerant. 0=407c, 1=410a
Capacity Offset	A208	0-100.0 F: 30.0	%	Offset from compressor capacity for EEV control range.
Compressor Delay	I4	0-999 F: 0, 3	s	Delay of compressor after EEV opening. 0s for Inverter units, 3s for On/Off units.
Glider Time	I304	0-999 F: 60	s	Time after compressor start, to glide evaporating/condensing reference temperatures from solid values to real ones, measured by pressure transducers, when Glider Mode is selected.

10.9.3 Evaporating Reference

```

Expansion Setting
Evaporating Reference
Heating Mode
Temperature: -10.0 %
Type: Glider
Cooling Mode
Temperature: 05.0 %
Type: Glider
    
```

Parameter:	SP	Range/F.:	Unit	Description
Evaporating Reference Heating Mode	A478	-99.9-99.9 F:*	°C	Evaporating reference for compressor capacity calculation in heating mode. For BW and WW units, the reference is the set temperature. For AW units it is relative value to actual outdoor temperature. Example: Outdoor = -2.0°C, Reference Set = -10°C. Resulting reference = -2.0+(-10.0)=-12°C
Heating Mode Evaporating Reference Type	I305	0-2 F: 0	-	Type of reference calculation in heating mode. 0=Reference T, 1=Suction T, 2=Glider.
Evaporating Reference Cooling Mode	A479	-99.9-99.9 F: 5.0	°C	Evaporating reference for compressor capacity calculation in cooling mode. It is relative value to actual water control temperature.
Cooling Mode Evaporating Reference Type	I306	0-2 F: 0	-	Type of reference calculation in cooling mode. 0=Reference T, 1=Suction T, 2=Glider.

10.9.4 Condensing Reference

```

Expansion Setting
Condensing Reference
Heating Mode
Temperature: 10.0 °C
Type: Condensing T
Cooling Mode
Temperature: 10.0 °C
Type: Condensing T
  
```

Parameter:	SP	Range/F.:	Unit	Description
Condensing Reference Heating Mode	A480	-99.9-99.9 F:10.0	°C	Condensing reference for compressor capacity calculation in heating mode. It is relative value to actual water control temperature.
Heating Mode Condensing Reference Type	I307	0-2 F: 1	-	Type of reference calculation in heating mode. 0=Reference T, 1=Discharge T, 2=Glider.
Cooling Mode Condensing Reference	A481	-99.9-99.9 F:10.0	°C	Condensing reference for compressor capacity calculation in cooling mode. For AW units it is relative value to outdoor temperature. For BW, WW units it is the set temperature.
Cooling Mode Condensing Reference Type	I308	0-2 F: 1	-	Type of reference calculation in heating mode. 0=Reference T, 1=Discharge T, 2=Glider.

10.9.5 EEV Steps

```

Expansion Settings
Manual Steps: 0000
Mode: Auto
StandBy Steps: 0030
StandBy Delay: 030 s
Defrost Steps: 0000
  
```

Parameter:	SP	Range/F.:	Unit	Description
Manual Steps	I168	0-9999 0-480E2V F: 0	-	Manual requested valve position.
Mode	B49	0 = Auto 1 = Manual	-	Activation of the manual valve position.
StandBy Steps	I153	0-9999 F: *	-	Valve position when compressor is Off.
StandBy Delay	I309	0-999 F: 30	s	Valve goes to StandBy position after delay from compressor stop.
Defrost Steps	I103	0-9999 F:*	-	Fixed valve position during defrost mode. When set to 0, EEV is automatically controlled. This setting is valid, when SGT or S/DGT control mode is chosen.

*Factory setting:

Unit type	StandBy Steps
AM, EM, BA, AQ	30
AQ22I	30
AQ30I	30
AQ45I	150

Unit type	Defrost Steps
AM, EM, BA	470
BA22I	470
BA30I	350
BA45I	470

10.9.6 EEV Capacity

```

EEExpansion Setting
EEV Capacity Setting
Auto = 000 %
Heating: 000 %
Cooling: 100 %
Defrost: 100 %
Automatic: 000 %
    
```

Parameter:	SP	Range/F.:	Unit	Description
EEV Capacity Heating	I165	0-100 F: 0	%	Valve capacity for heating mode. When set to 0%, automatic calculation is used, according to compressor type and circuit actual conditions.
EEV Capacity Cooling	I164	0-100 F: 0	%	Valve capacity for cooling mode. When set to 0%, automatic calculation is used, according to compressor type and circuit actual conditions.
EEV Capacity Defrost	I166	0-100 F: 100	%	Valve capacity for defrost mode. When set to 0%, automatic calculation is used, according to compressor type and circuit actual conditions.
Automatic	I310	0-100	%	Result of automatic calculation.

10.9.7 EEV Control Type

```

EEExpansion Setting
Control Type:
DGT
DGT Mode:
EUD Evolution
S4_Time: 050.0
Actual:
Discharge Superheat
    
```

Parameter:	SP	Range/F.:	Unit	Description
Control Type	I191	0-3 F: *	-	EEV control mode setting. 0=DGT: Discharge Gas Superheat. 1=SGT: Conventional Suction Gas Superheat. 2=DGT/SGT: DGT for heating mode and SGT for cooling mode. 3=SDGT/SGT: Combination of SGT and DGT for heating mode and SGT for cooling mode.
DGT Mode	B53	0/1 F: 1	-	Type of DGT control. 0: EVD Evo automatic control 1: pCO ⁵ custom (manual) control. In this case special control routine from main controller is used.
S4_Time	A482	0.1-800.0 F: 20.0	-	DGT probe antfilter constant. System is able to assume target DGT, considering inertia of the heat transmsion of hot gas -> probe.
Actual	B47	0/1	-	Actual control mode. 0=Suction Superheat 1=Discharge Superheat

*Factory setting:

Unit type	Control Type
AM, EM	0, DGT
AM/EM Reversible, BA	2, DGT/SGT
BAI	3, SDGT/SGT
AQ	1, SGT

10.9.8 DGT Temperature Setting

```

Expansion Setting
DGT Setting DSuperheat
T.Reference A: 20.0 °C
DSuperheat A20:30.0 °C
DSuperheat A50:37.0 °C
T.Reference B: -20.0 °C
DSuperheat B20:35.0 °C
DSuperheat A50:42.0 °C
  
```

Parameter:	SP	Range/F.:	Unit	Description
DGT Temperature Reference A	A483	-99.9-99.9 F: *	°C	Outdoor temperature reference, point A.
Discharge Superheat A20	A29	-99.9-99.9 F: *	°C	Requested discharge superheat for condensing temperature 20°C, reference point A.
Discharge Superheat A50	A30	-99.9-99.9 F: *	°C	Requested discharge superheat for condensing temperature 50°C, reference point A.
DGT Temperature Reference B	A484	-99.9-99.9 F: *	°C	Outdoor temperature reference, point B.
Discharge Superheat B20	A31	-99.9-99.9 F: *	°C	Requested discharge superheat for condensing temperature 20°C, reference point B.
Discharge Superheat B50	A32	-99.9-99.9 F: *	°C	Requested discharge superheat for condensing temperature 50°C, reference point B.

*Factory Setting:

Parameter	unit	SP	AM	EM BA	BA22Z BAI	AQ	AQI
DGT Temperature Reference A	°C	A483	20.0	20.0	20.0	20.0	20.0
Discharge Superheat A20	°C	A29	30.0	35.0	30.0	30.0	30.0
Discharge Superheat A50	°C	A30	37.0	42.0	37.0	37.0	37.0
DGT Temperature Reference B	°C	A484	-20.0	-20.0	-20.0	-20.0	-20.0
Discharge Superheat B20	°C	A31	35.0	40.0	35.0	30.0	30.0
Discharge Superheat B50	°C	A32	42.0	47.0	42.0	37.0	37.0

10.9.9 DGT Configuration

```

EEExpansion Setting
DGT Setting

CT Source: Discharge T
Inverter Cor.: -10.0 °C
Actual Cor.: 00.0 °C
DSHeat Set: 0000.5 °C
DGT Set: 0000.5 °C
    
```

Parameter:	SP	Range/F.:	Unit	Description
CT Source	B54	0/1 F: 1	-	Condensing temperature source. 0=Discharge T: condensing temperature 1=Water: heating water temperature
Inverter Cor.	A485	-99.9-99.9 F: -10.0	°C	Inverter correction for requested DGT. This correction is corresponding to 0rps for inverter models.
Actual Cor.	-	-99.9-99.9	°C	Actual calculated inverter requested DGT correction.
DSHeat Set	A8	-999-999	°C	Actual requested discharge superheat.
DGT Set	A486	-999-999	°C	Actual requested DGT

10.9.10 DGT PID Setting

```

EEExpansion Setting
DGT Setting PID

P Band: 100.0 %
I Time: 100 s
D Time: 020 s
Period: 2000 ms
    
```

Parameter:	SP	Range/F.:	Unit	Description
P Band	A26	0-999.9 F: 100.0	°C	EEV control proportional band for DGT mode. Lower value speeds up control.
I Time	I3	0-999 F: 100	s	EEV control integration time. Lower value speeds up reaching the setpoint, but with risk of instability.
D Time	I2	0-999 F: 20	s	EEV control deriavation time. Higher value speeds up reaching the setpoint, but with risk of instability.
Period	I311	0-9999 F: 2000	ms	PID control period. Do not set lower than 1000.

10.9.11 DGT Timing



Parameter:	SP	Range/F.:	Unit	Description
DGT Begin Time	I1	0-999 F: 120	s	DGT mode starts with solid EEV setting to reach stable circuit situation. PID control begins after DGT Begin Time.
Defrost Set	A25	0-100.0 F: 90.0	%	Opening of the valve in defrost mode. Valid only for DGT mode.
EEV Manual	A9	0-100.0 F: 000.0	%	Manual valve positioning during DGT control. When set to 0%, automatic operation.

10.9.12 S/DGT Setting

```

Expansion Setting
S/DGT Setting

DGT DSht >      01.0 °C
SGT DSht <      15.0 °C

SDGT Active: No
  
```

Parameter:	SP	Range/F.:	Unit	Description
DGT DSht >	A17	-99.9-99.9 F: 1.0	°C	Offset to start DGT control beside SGT control. When discharge superheat (DSht) is higher then setpoint + offset, control switches from SGT to DGT mode.
SGT DSht <	A18	-99.9-99.9 F: 15.0	°C	Offset to start SGT control beside DGT control. When DSht is lower than setpoint - offset, control switches from DGT to SGT.
SDGT Active	B45	0/1	-	0=SGT mode, 1=DGT mode.

10.9.13 SGT Superheat, MOP

```

Expansion Setting
SGT Setting

Superheat:      008.0 °C
MOP HT:         20.0 °C
MOP CO:         20.0 °C
MOP DF:         20.0 °C
MOP Alr Delay: 00360 s
MOP_Ti:         020.0 s
  
```

Parameter:	SP	Range/F.:	Unit	Description
Superheat	A174	-999-999 F: 6.0	°C	Suction superheat setpoint in case if SGT control.
MOP HT	A169	-99.9-99.9 F: 20.0	°C	Maximum Opening Pressure (MOP) setpoint for heating mode. When evaporating temperature is higher than setpoint, EEV starts closing to limit evaporating temperature.
MOP CO	A168	-99.9-99.9 F: 20.0	°C	Maximum Opening Pressure (MOP) setpoint for cooling mode.
MOP DF	A170	-99.9-99.9 F: 20.0	°C	Maximum Opening Pressure (MOP) setpoint for defrost mode.
MOP Alr Delay	I155	0-18000 F: 360	s	When MOP is not reached in this time, MOP Alarm is activated.
MOP_Ti	A487	0.0-800.0 F: 20.0	s	MOP control integration time.

10.9.14 SGT LOP

```

Expansion Setting
SGT Setting

LOP:                -0030.0 °C

LOP Air Delay: 00360 s
LOP_Ti:            015.0 s
  
```

Parameter:	SP	Range/F.:	Unit	Description
LOP Heating/Cooling	A166	-99.9-99.9 F: AW=-30.0 BW=-12.0 WW=+2.0	°C	Lowest Opening Pressure (LOP) setpoint. When evaporating temperature is lower than setpoint, EEV starts opening to limit evaporating temperature.
LOP Air Delay	I154	0-18000 F: 360	s	When LOP is not reached in this time, LOP Alarm is activated.
LOP_Ti	A488	0.0-800.0 F: 15.0	s	LOP control integration time.

10.9.15 SGT Superheat Low

```

Expansion Setting
SGT Setting

SHL:                002.0 °C

SHL Air Delay: 00360 s
SHL_Ti:            015.0 s
  
```

Parameter:	SP	Range/F.:	Unit	Description
SHL	A177	-99.9-99.9 F: 2.0	°C	Superheat Low setpoint. When superheat is lower than setpoint, EEV starts faster closing to reach at least minimum superheat.
SHL Air Delay	I156	0-18000 F: 360	s	When at least SHL is not reached in this time, SHL Alarm is activated.
SHL_Ti	A489	0.0-800.0 F: 15.0	s	SHL control integration time.

10.9.16 SGT EVD Setting

EVD – PID settings of the EEV valve control in SGT mode.



Parameter:	SP	Range/F.:	Unit	Description
EVD Pk	-	-99.9-99.9 Hodnota: 15.0	°C	Proportional band for PID control of EEV.
EVD Ik	-	0-9999 Hodnota: 150	s	Integration time for PID control of EEV.
EVD Dk	-	0.0-800.0 Hodnota: 5.0	s	Derivation time for PID control of EEV.

10.9.17 Expansion Info DGT

DGT control information screen.

```

Expansion Info DGT
StSht/DSht:08.0 /00.5
PV:0000      Power:005%
RegSubtype: 9  A:000.0
DGTControl: 0  R:000.5
EEVDGTON:   0  O:0000
EEVDGTMan:  0  010.0%
                PIDON:0
  
```

Parameter:	SP	Range/F.:	Unit	Description
StSht	A181	-99.9-99.9	°C	Suction Superheat Setpoint.
StDSht	A8	-99.9-99.9	°C	Discharge Superheat Setpoint.
PV	I169	0-9999	-	Actual valve position.
Power	I167	0-100	%	Requested valve capacity.
RegSubtype	I312	0-2	-	Evd Evolution control type, when it is used for control. 1=SGT, 2=DSheat, 3=DGT.
DGTControl	B340	0/1	-	When DGT control enabled = 1.
EEVDGTON	B341	0/1	-	Request from pCO to EVD Evolution to start DGT control.
EEVDGTMan	B342	0/1	-	Request to start pCO special control of DGT.
A	A7	0-999.9	°C	Actual discharge superheat.
R	A8	0-999.9	°C	Requested discharge superheat
O	-	-1000-1000	-	Actual PID output of DGT control in relative values.
O	A490	0-100.0	%	Actual PID output of DGT control in % opening of valve.
PIDON	B343	0/1	-	PID control of DGT active=1.

10.9.18 Expansion Info SDGT

```

EEExpansion Info SDGT
StSht/DSht:08.0 /00.5
PV:0000 Power:005%
RegSubtype: 9 A:000.0
DGTControl: 0 R:000.5
EEVSDGTON: 0 O:0000
EEVDGTMan: 0 000.0%
PIDON:0
  
```

Parameter:	SP	Range/F.:	Unit	Description
StSht	A181	-99.9-99.9	°C	Suction Superheat Setpoint.
StDSht	A8	-99.9-99.9	°C	Discharge Superheat Setpoint.
PV	I169	0-9999	-	Actual valve position.
Power	I167	0-100	%	Requested valve capacity.
RegSubtype	I312	0-2	-	Evd Evolution control type, when it is used for control. 1=SGT, 2=DSheat, 3=DGT.
DGTControl	B340	0/1	-	When DGT control enabled = 1.
EEVSDGTON	B344	0/1	-	Request from pCO to EVD Evolution to start SDGT control.
EEVDGTMan	B342	0/1	-	Request to start pCO special control of DGT.
A	A7	0-999.9	°C	Actual discharge superheat.
R	A8	0-999.9	°C	Requested discharge superheat
O	-	-1000-1000	-	Actual PID output of SDGT control in relative values.
O	A491	0-100.0	%	Actual PID output of SDGT control in % opening of valve.
PIDON	B346	0/1	-	PID control of SDGT active=1.

10.9.19 EExpansion Set EVI - 1.part

```

EEExpansion Set EVI
RPS > 030.0 H: 1.0 rps
ET < 12.0 H: 1.0 %
CT < 58.0 H: 1.0 %
ETA:-18.0 CTA:10.0 %
ETB:12.0 CTB:47.0 %
CTAB:047.0 H: 1.0 %
Enabled: No
  
```

Parameter:	SP	Range/F.:	Unit	Description
RPS >	-	0-99.9	-	Compressor speed have to higher then EVI activation set limit.
H	-	0-9.9	rps	Compressor Speed Hysteresis (+/-).
ET<	-	99.9-99.9	°C	Evaporation temperature have to lower then EVI activation set limit.
H	-	0-9.9	°C	Hysteresis limit for Evaporation temperature (+/-).
CT<	-	99.9-99.9	°C	Condensation temperature have to lower then set limit.
H	-	0-9.9	°C	Hysteresis limit for Condensation temperature. (+/-)
ETA	-	99.9-99.9	°C	Temperature line, Evaporation point A
CTA	-	99.9-99.9	°C	Temperature line, Condensation point A
ETB	-	99.9-99.9	°C	Temperature line, Evaporation point B
CTB	-	99.9-99.9	°C	Temperature line, Condensation point B
CTAB	-	99.9-99.9	°C	Condensation temperature calculated from AB line. Actual value have to higher then calculated value for EVI activated.
H	-	0-9.9	°C	Hysteresis of Condensation temperature AB (+/-).
Enabled	-	0/1	-	1=Yes, 0=No

10.9.20 EExpansion Set EVI - 2.part

```

EExpansion Set. EVI
Par. Real Set =
RPS: 000.0 > 030.0 0
ET: 000.0 < 12.0 0
CT: 000.0 < 58.0 0
CT: 000.0 > 047.0 0
Compressor On: 0
EVI ON: 0
  
```

Parameter:	SP	Range/F.:	Unit	Description
RPS	-	Real>Set /=	rps	Real rotate per second (rps)>set point/0-not comply the condition, 1- comply the condition.
ET	-	Real<Set /=	°C	Real evaporation temperature<set point/0-not comply the condition, 1- comply the condition.
CT	-	Real<Set /=	°C	Real condensation temperature<set point/0-not comply the condition, 1- comply the condition.
CT	-	Real>Set /=	°C	Real condensation temperature>set point/0-not comply the condition, 1- comply the condition.
CompOn	-	0/1	-	1=compressor On, 0 = compressor Off
EVI ON	-	0/1	-	1=EVD EVI module switch On, 0 = Off

10.9.21 EEV Default Setting

Used to return basic setting of EEV and pair/preset EVD Evolution with pCO.

```

EExpansion Setting
Default Setting
R407c: No
R410a: No
  
```

Parameter:	SP	Range/F.:	Unit	Description
Default Setting R407c	-	0/1	-	When set to 1(Yes), procedure of default setting is started. It is returned to 0(No) automatically. It takes at least 2 minutes until procedure is finished. Use this for units with 407c refrigerant and 410a refrigerant as well.
Default Setting R410a	-	0/1	-	Additional procedure for units with 410a refrigerant. Default setting for 407c must be performed before 410a procedure !

10.10 Speed Set

Parameters to set Inverter control.

10.10.1 Speed Info

```
Speed Info
Temperature
Requested: 00.0 °C
Real: 36.0 °C
Speed
Requested: 001.0 rps
Real: 010.0 rps
```

Parameter:	SP	Range/F.:	Unit	Description
Temperature Requested	-	-99.9-99.9	°C	Requested water temperature for speed control.
Temperature Real	A1	-99.9-99.9	°C	Real heating control water temperature.
Speed Requested	A450	0-100.0	rps	Requested compressor speed.
Speed Real	A148	0-100.0	rps	Manual requested speed of compressor.
Real	A159	0-100.0	rps	Real Requested compressor speed, considering speed limitations and speed timing.

10.10.2 Speed Setting Heating

Operating map for heating mode.

```
Speed Setting Heating
Temperature A: 20.0 °C
Min Speed: 030.0 rps
Max Speed: 060.0 rps
Temperature B: -20.0 °C
Min Speed: 060.0 rps
Max Speed: 090.0 rps
SHW Max Speed: 060.0 rps
```

Parameter:	SP	Range/F.:	Unit	Description
Temperature A	A130	-99.9-99.9 F: 20.0	°C	Outdoor temperature reference point A.
Min Speed A	A132	0-100.0 F: 30.0	rps	Minimum speed for reference point A.
Max Speed A	A133	0-100.0 F: 60.0	rps	Maximum speed for reference point A.
Temperature B	A131	-99.9-99.9 F: -20.0	°C	Outdoor temperature reference point B.
Min Speed B	A134	0-100.0 F: 60.0	rps	Minimum speed for reference point B.
Max Speed B	A135	0-100.0 F: 90.0	rps	Maximum speed for reference point B.
SHW Max Speed	A16	0-100.0 F: 80.0	rps	Maximum speed in generating hot water (SHW)

10.10.3 Speed Setting Cooling

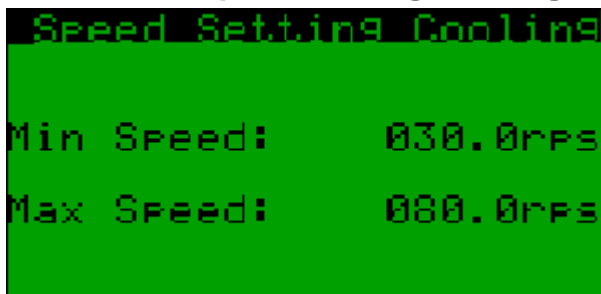

```

Speed Setting Cooling
Min Speed: 030.0rps
Max Speed: 080.0rps
  
```

Parameter:	SP	Range/F.:	Unit	Description
Cooling Min Speed	A451	0-100.0 F: 30.0	rps	Minimum speed for cooling mode.
Cooling Max Speed	A452	0-100.0 F: 80.1	rps	Maximum speed for cooling mode.

10.10.4 Speed Setting Offset

```

Speed Setting Offset
-----
Heating:      00.0  %
Cooling:      00.0  %
  
```

Parameter:	SP	Range/F.:	Unit	Description
Offset Heating	A429	-99.-99.9 F: 2.5	°C	Offset from water setpoint for speed control in heating mode. Speed water setpoint = heating water setpoint - Offset Heating.
Offset Cooling	A430	-99.-99.9 F: 2.5	°C	Offset from water setpoint for speed control in cooling mode. Speed water setpoint = cooling water setpoint + Offset Cooling.

10.10.5 Speed Setting PID

```

Speed Setting PID
-----
P Band:      015.0  %
I Time:      100  s
D Time:      020  s
Period:      1000  ms
Direction:    0
Filter:      001.0  rps
  
```

Parameter:	SP	Range/F.:	Unit	Description
P Band	A136	0-999.9 F: 15.0	°C	Speed control proportional band. Lower value speeds up control.
I Time	I114	0-999 F: 100	s	Speed control integration time. Lower value speeds up reaching the setpoint, but with risk of instability.
D Time	I113	0-999 F: 20	s	Speed control deriavation time. Higher value speeds up reaching the setpoint, but with risk of instability.
Period	I115	0-9999 F: 1000	ms	PID control period. Do not set lower than 1000.
Direction	B80	0/1 F: 0	-	Directional of speed PID control. Direct or Reverse. Always it must be 0.
Filter	-	0-100.0 F: 1.0	rps	Output filter from PID control to avoid shock output change. RPS per program cycle.

10.10.6 Speed Setting Defrost

```

Speed Setting Defrost
Min Speed: 050.0 rps
Max Speed: 080.0 rps
Manual Speed:060.0 rps
Mode: Automatic
Evap Request:02.0 °C
Evap Real: 000.0 °C
Output: 010.0 rps
  
```

Parameter:	SP	Range/F.:	Unit	Description
Defrost Min Speed	A138	0-100.0 F: 50.0	rps	Minimum speed for defrost mode.
Defrost Max Speed	A139	0-100.0 F: 80.0	rps	Maximum speed for defrost mode.
Defrost Manual Speed	A137	0-100.0 F: 60.0	rps	When Manual Mode selected, defrost compressor speed.
Defrost Mode	B81	0/1 F: 1	-	Defrost speed control mode. 0=Manual 1=Automatic
Evap Request	A153	-99.9-99.9 F: 2.0	°C	Requested evaporating temperature for speed control in defrost mode.
Evap Real	A80	-99.9-99.9	°C	Real evaporating temperature.
Output	A159	0-100.0	rps	Output of the defrost speed control

10.10.7 Speed Defrost PID

```

Speed Setting Defrost
PID Setting
P Band: 010.0 %
I Time: 050 s
D Time: 010 s
Period: 1000 ms
  
```

Parameter:	SP	Range/F.:	Unit	Description
P Band	A152	0-999.9 F: 10.0	°C	Defrost speed control proportional band. Lower value speeds up control.
I Time	I118	0-999 F: 50	s	Defrost speed control integration time. Lower value speeds up reaching the setpoint, but with risk of instability.
D Time	I117	0-999 F: 10	s	Defrost speed control deriavation time. Higher value speeds up reaching the setpoint, but with risk of instability.
Period	I119	0-9999 F: 1000	ms	PID control period. Do not set lower than 1000.

10.10.8 Speed Setting Config

```

Speed Setting Config
Start Speed: 050.0 rps
Start Time: 060 s

Step Speed: 005.0 rps
Step Time: 030 s
  
```

Parameter:	SP	Range/F.:	Unit	Description
Start Speed	A453	0-100.0 F: 50.0	rps	Compressor start speed. Compressor starts with the fixed speed for Start Time.
Start Time	I120	0-999 F: 90	s	Time after compressor start to keep fixed speed.
Step Speed	A454	0-100.0 F: 5.0	rps	Step of compressor speed change. This is to avoid frequent change of speed, damaging lubrication and bearings.
Step Time	I124	0-999 F: 30	s	Minimum time compressor must keep the actual speed.

10.10.9 Speed Setting Limits

```

Speed Setting Config
Setting Limits
Min Speed: 030.0 rps
Max Speed: 100.0 rps
AlrMinSpeed: 025.0 rps
AlrMinSpeedDelay: 060 s
AlrMinPD: 03.0 bar
AlrMinPDDelay: 090 s
  
```

Parameter:	SP	Range/F.:	Unit	Description
Min Speed	A455	0-100.0 F: 30.0	rps	Minimum compressor speed limit.
Max Speed	A456	0-100.0 F: 100.0	rps	Maximum compressor speed limit.
AlrMinSpeed	-	0-200 F: 25.0	rps	Minimal speed limit. When compressor speed drops below this limit during operation → alarm is activated.
AlrMinSpeedDelay	-	0-999 F: 60	s	Setting Alarm delay for minimal speed (after compressor start).
AlrMinPD	-	0-99,9 F: 1.0	bar	Setting pressure difference limit – When limit drops below minimal value during compressor operation → alarm is activated.
AlrMinPDDelay	-	0-999 F: 180	s	Setting Alarm delay for minimal pressure difference limit (after compressor start).

10.10.10 Speed Compressor Map

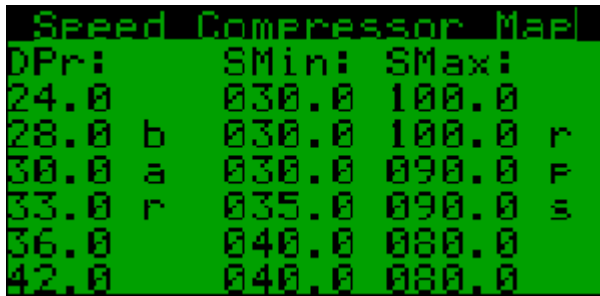

DPr:	SMin:	SMax:
24.0	030.0	100.0
28.0 b	030.0	100.0 r
30.0 a	030.0	090.0 F
33.0 r	035.0	090.0 s
36.0	040.0	080.0
42.0	040.0	080.0

Parameter:	SP	Range/F.:	Unit	Description
DPr	*	0-99.9 F: *	bar	Pressure reference value for operating range of minimum and maximum speeds.
SMin	*	0-100.0 F: *	rps	Minimum speed to corresponding pressure reference.
SMax	*	0-100.0 F: *	rps	Maximum speed to corresponding pressure reference.

* Factory setting

Inverter Model	DPr(bar)	SP	SMin(rps)	SP	SMax(rps)	SP
22l 30l 45l	24.0	A457	30.0	A463	90.0	A469
	28.0	A458	30.0	A464	90.0	A470
	30.0	A459	30.0	A465	90.0	A471
	33.0	A460	35.0	A466	90.0	A472
	36.0	A461	40.0	A467	80.0	A473
	42.0	A462	40.0	A468	80.0	A474
45l1	24.0	A457	30.0	A463	90.0	A469
	28.0	A458	30.0	A464	90.0	A470
	30.0	A459	30.0	A465	80.0	A471
	33.0	A460	35.0	A466	70.0	A472
	36.0	A461	40.0	A467	50.0	A473
	42.0	A462	40.0	A468	50.0	A474

10.10.11 Speed Setting – CrankCase Heater

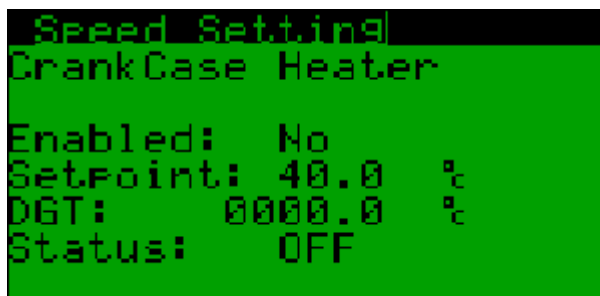

Speed Setting	
CrankCase Heater	
Enabled:	No
Setpoint:	40.0 %
DGT:	0000.0 %
Status:	OFF

Parameter:	SP	Range/F.:	Unit	Description
Enabled	-	0/1 Yes/No F: No	-	Setting heating. Yes-On heating, No-Off heating.
Setpoint	-	-99.9/+99.9 F: 40	°C	Setting discharge temperature for compressor heating.
DGT	-	-9999/9999	°C	Actual Discharge Gas Temperature.
Status	-	0/1	-	Off/On – Status heating.

10.10.12 Speed Drive Status (Info)

```

Speed Drive Status
Run Req/Real: 0 / 0
Speed Req: 010.0 rps
Speed Real: 000.0 rps
0000 V/000.0 A/000.0kW
DC0000V/000 %
Status: Stop
No Alarm
  
```

Parameter:	SP	Range/F.:	Unit	Description
Run Req	B410	0/1	-	Request to start refrigeration circuit.
Run Real	B411	0/1	-	Request to run the compressor.
Speed Req	A159	0-100.0	rps	Requested compressor speed.
Speed Real	A475	0-100.0	rps	Real compressor speed.
Volts	I295	0-9999	V	Compressor voltage.
Amps	A476	0-999.9	A	Compressor current.
kW	A477	0-999.9	kW	Compressor power.
DC	I296	0-9999	V	DC drive voltage.
°C	I297	0-999	°C	Drive temperature.
Status	I298	0-2	-	Drive status: 0:Stop, 1:Run, 2:Alarm
Alarm	I299	0-99	-	Drive Alarm Code.

10.10.13 DC drive – Alarms table:

I299	Typ Alarmu
0	No fault
1	Overcurrent
2	Motor overload
3	Overvoltage
4	Undervoltage
5	Drive overT
6	Drive underT
7	Overcurrent HW
8	Motor overtemp
9	Drive failure
10	Cpu error
11	Param. default
12	DC bus ripple
13	Data comms fault
14	Drive thermistor
15	Autotune fault
16	Drive disabled = High Pressure Switch alarm
17	Motor phase fault
18	Fan fault
19	Speed fault
20	PFC failure
21	error code 21, reserved
22	PFC undervoltage
23	STO survey fail
24	STO survey fail
25	Ground fault
26	Internal error 1
27	Internal error 2
28	Drive overload
29	Drive overtemp
30	error code 30, reserved
98	Unexpected Inverter Restart
99	Unexpected Inverter Stop

10.10.14 Speed Drive Setting (entrance to DC drive menu)



Pressing ENTER moves to DC Drive Menu.

10.10.15 Speed Brine Control

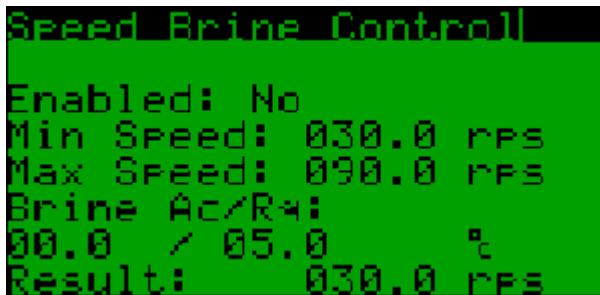

Parameter:	SP	Range/F.:	Unit	Description
Brine Control Enabled	B419	0/1 F: 0	-	Enable speed limitation according to the brine temperature. When brine temperature is decreasing, system is limiting the maximum speed.
Brine Control Min Speed	A437	0-100.0 F: 30.0	rps	Minimum speed limit for brine control.
Brine Control Max Speed	A438	0-100.0 F: 90.0	rps	Maximum speed limit for brine control.
Brine Ac	A433	-99.9-99.9	°C	Actual brine temperature.
Brine Rq	A434	-99.9-99.9 F: 5.0	°C	Brine temperature control setpoint.
Result	A439	0-100.0	rps	Result of brine temperature control speed limitation.

10.11Evd Evolution

Reserved for Manufacturer.

10.12 Protocols Set

Setting of pCO⁵ communication.

10.12.1 Ports Information

```

Ports Information
  Pr BR   S P Adr SO
B1:01/19200/2/0/001 0
B2:01/19200/2/0/001 0
F1:01/19200/2/0/001 0
F2:07/19200/2/0/001
  
```

Parameter:	SP	Range/F.:	Unit	Description
Pr	-	1-99	-	Protocol type used on ports 1: Carel; 3: Modbus Slave, 18: Carel Master V2, 21: Modbus Master 2.0, 28: Modbus Master 2.0, 30: Modbus Slave Extended, 33: Modbus Slave Extended, 54: Carel Master V1, 60: Modbus Master 3.0
BR	-	1200, 2400, 4800, 9600, 19200, 38400	bps	Baud Rate.
S	-	0/1	-	Stop Bits. 0=2, 1=1
P	-	0-2	-	Parity. 0=none, 1=even, 2=odd.
Adr	-	1-207	-	Address of the port for slave protocols.
SO	-	0/1	-	Connected to Supervisor. 1=Yes.

10.12.2 BMS Configuration

```

Ports Configuration
BMS Port
Protocol:
Modbus Master n.2
Baudrate: 19200
Stopbit: 2
Parity: None
BMS Address: 001
  
```

Parameter:	SP	Range/F.:	Unit	Description
BMS Protocol	-	1-14 F: 11	-	Protocol type used on port BMS. 0:Reserved; 1:Carel Slave Local, 2:Carel Slave Remote, 3:Modbus Slave, 4:Winload, 5:Benshaw, 6:GSM Modem, 7:Wireless Kiocera, 8:Printer, 9: Carel Master v.2, 10:Modbus Master, 11:Modbus Master n.2 , 12:Modbus Slave Ext.30, 13:Modbus Slave Ext.33, 14:Carel Master v.1
BMS Baudrate	-	0-5 F: 4	-	Baudrate used on port BMS. 0:1200, 1:2400; 2:4800, 3:9600, 4:19200, 5:38400
BMS Stopbit	-	0/1 F: 0	-	BMS stopbit configuration. 0: 2 stopbits, 1: 1 stopbit
BMS Parity	-	0-2 F: 0	-	BMS parity. 0:None, 1:Even, 2:Odd
BMS Address	-	1-207 F: 1	-	BMS address used for slave protocols.

10.12.3 BMS2 Configuration

```

Ports Configuration
BMS2 Port
Protocol:
Modbus Slave Ext.33
Baudrate: 19200
Stopbit: 2
Parity: None
BMS Address: 001
  
```

Parameter:	SP	Range/F.:	Unit	Description
BMS2 Protocol	-	1-5 F: 5	-	Protocol type used on port BMS2. 0:Reserved; 1:Carel Slave Local; 2:Carel Master v.2; 3:Modbus Master; 4:Modbus Master n.2; 5:Modbus Slave Ext.33
BMS2 Baudrate	-	0-5 F: 4	-	Baudrate used on port BMS2. 0:1200, 1:2400; 2:4800, 3:9600, 4:19200, 5:38400
BMS2 Stopbit	-	0/1 F: 0	-	BMS2 stopbit configuration. 0: 2 stopbits, 1: 1 stopbit
BMS2 Parity	-	0-2 F: 0	-	BMS2 parity. 0:None, 1:Even, 2:Odd
BMS2 Address	-	1-207 F: 1	-	BMS address used for slave protocols.

10.12.4 FieldBus Configuration

```
Ports Configuration
FieldBus port
Protocol:
Modbus Master n.2
Baudrate: 19200
Stopbit: 2
Parity: None
FBus Address: 001
```

Parameter:	SP	Range/F.:	Unit	Description
FieldBus Protocol	-	1-16 F: 14	-	Protocol type used on port FieldBus. 1:Belimo; 2:PST; 3:Carel Slave Local; 4:Modbus Slave; 5:GSM Modem; 6:Wireless Kyocera; 7: Carel Slave Remote; 8:Printer; 9:Winload; 10:Carel Master v.2; 11:Th-Tune; 12:tLAN Master; 13:Modbus Master; 14:Modbus Master n.2 ; 15:Modbus Slave Extended; 16:Carel Master v.1
FB Baudrate	-	0-5 F: 4	-	Baudrate used on port FieldBus. 0:1200, 1:2400; 2:4800, 3:9600, 4:19200, 5:38400
FB Stopbit	-	0/1 F: 0	-	FieldBus stopbit configuration. 0: 2 stopbits, 1: 1 stopbit
FB Parity	-	0-2 F: 0	-	FieldBus parity. 0:None, 1:Even, 2:Odd
FB Address	-	1-207 F: 1	-	FieldBus address used for slave protocols.

10.12.5 FieldBus 2 Configuration

```
Ports Configuration
FieldBus2 port
Protocol:
Carel Master v.2
Baudrate: 19200
Stopbit: 2
Parity: None
FBus2 Address: 001
```

Parameter:	SP	Range/F.:	Unit	Description
FB2 Protocol	-	1-16 F: 2	-	Protocol type used on port FieldBus2. 1:tLAN Master; 2:Carel Master v.2 ; 3:Modbus Master; 4:Modbus Master n.2
FB2 Baudrate	-	0-5 F: 4	-	Baudrate used on port FieldBus2. 0:1200, 1:2400; 2:4800, 3:9600, 4:19200, 5:38400
FB2 Stopbit	-	0/1 F: 0	-	FieldBus2 stopbit configuration. 0: 2 stopbits, 1: 1 stopbit
FB2 Parity	-	0-2 F: 0	-	FieldBus2 parity. 0:None, 1:Even, 2:Odd
FB2 Address	-	1-207 F: 1	-	FieldBus2 address used for slave protocols.

10.12.6 pLAN Configuration

pLAN port is used pGD displays and for MasterLAN applications.

```

Ports Configuration
pLAN
T1: Private Address:32
T2: Private Address:31
T3: Private Address:30
Set Terminals: No
pCO Address: 01
  
```

Parameter:	SP	Range/F.:	Unit	Description
T1 Address:	-	0/1 F: 0 Address: 01-32 F: 32	-	Type of terminal T1 0=Private, 1=Shared Type of address.
T2 Address:	-	0/1 F: 0 Address: 01-32 F: 31	-	Type of terminal T2 0=Private, 1=Shared Type of address.
T3 Address:	-	0/1 F: 0 Address: 01-32 F: 30	-	Type of terminal T3 0=Private, 1=Shared Type of address.
Set Terminals	-	No/Yes	-	Set Yes to store terminals configuration.
pCO Address	-	0-31 F: 1	-	pLAN address of pCO5.

10.12.7 Modbus Master Configuration

2 Modbus Master protocols are used on pCO controller.

```
ModBus Master Config
MBMaster 1 Port: FB1
Enabled: 1
R:UART set OK

MBMaster 2 Port: BMS1
Enabled: 1
R:UART set OK
```

Parameter:	SP	Range/F.:	Unit	Description
MBMaster 1 Port	-	0-4 F: 2	-	Port used for Modbus Master 1. 0:pLAN; 1:BMS1; 2:FB1; 3:BMS2; 4:FB2
MBMaster 1 Enabled	-	0/1 F: 1	-	Enabling Modbus Master 1 protocol.
MBMaster 1 R	-	0-3	-	Result of Modbus Protocol 1 operation. 0:UART set OK; 1:Commands OK; 2:UART incorrect; 4:Generic Error
MBMaster 2 Port	-	0-4 F: 1	-	Port used for Modbus Master 2. 0:pLAN; 1:BMS1; 2:FB1; 3:BMS2; 4:FB2
MBMaster 2 Enabled	-	0/1 F: 1	-	Enabling Modbus Master 2 protocol.
MBMaster 2 R	-	0-3	-	Result of Modbus Protocol 2 operation. 0:UART set OK; 1:Commands OK; 2:UART incorrect; 4:Generic Error

10.12.8 Modbus Master 1st Configuration

1st Modbus Master is used for communication with pAD room terminals and pCOe expansion.

```
Configuration
Modbus settings
1st Master
Baudrate: 19200
Stop bit: 2
Parity mode: NONE
Timeout: 0300ms
```

Parameter:	SP	Range/F.:	Unit	Description
1st Master Baudrate	-	0-5 F: 4	-	Baudrate used for 1st Master. 0:1200, 1:2400; 2:4800, 3:9600, 4:19200, 5:38400
1st Master Stopbit	-	0/1 F: 0	-	1st Master stopbit configuration. 0: 2 stopbits, 1: 1 stopbit
1st Master Parity mode	-	0-2 F: 0	-	1st Master parity. 0:None, 1:Even, 2:Odd
1st Master Timeout	-	0-9999 F: 300	ms	1st Master timeout.

10.12.9 Modbus Master 2nd Configuration

2nd Modbus Master is used for communication with DC Drive.

```

Configuration
Modbus settings
2nd Master
Baudrate:      19200
Stop bit:      2
Parity mode:   NONE
Timeout:       0300ms
  
```

Parameter:	SP	Range/F.:	Unit	Description
2nd Master Baudrate	-	0-5 F: 4	-	Baudrate used for 2nd Master. 0:1200, 1:2400; 2:4800, 3:9600, 4:19200, 5:38400
2nd Master Stopbit	-	0/1 F: 0	-	2nd Master stopbit configuration. 0: 2 stopbits, 1: 1 stopbit
2nd Master Parity mode	-	0-2 F: 0	-	2nd Master parity. 0:None, 1:Even, 2:Odd
2nd Master Timeout	-	0-9999 F: 300	ms	2nd Master timeout.

10.12.10 Carel Master Configuration

Carel Master protocol is used for communication with EEV driver EVD Evolution.

```

Carel Master Config
Baudrate: 19200
Retry:    03
ORT:      015 s
Enable:   1
CurrUnit: 000
LstError: 000
PrntError: 000
  
```

Parameter:	SP	Range/F.:	Unit	Description
Carel Master Baudrate	-	0-5 F: 4	-	Baudrate used for 2nd Master. 0:1200, 1:2400; 2:4800, 3:9600, 4:19200, 5:38400
Retry	-	0-20 F: 3	-	Retries before Offline error.
ORT	-	0-999 F: 15	-	Time between attempts when Offline error.
Enable	-	0/1 F: 1	-	Enables Carel Master protocol. 1=Enabled
CurrUnit	-	1-207	-	Unit address currently communicating.
LstError	-	1-207	-	Address of the first peripheral that did not correctly allocate list size.
PrtError	-	0-999	-	Protocol Error Code.

10.13 I/O Configuration

Configuration of Inputs and Outputs.

10.13.1 B1 to B3 Probes

```

I/O Config
Analog input B00
Probe type:          NTC
Offset:              0000.0
                    0000.0
                    1000.0

Alarm delay:        00060s
  
```

Parameter:	SP	Range/F.:	Unit	Description
B1 Probe type	-	0-12 F: 0	-	B1 probe type definition. 0:NTC; 1:PT1000; 2:0-1V; 3:0-10V; 4:0-20mA; 5:4-20mA; 6:ON/OFF; 7:0-5V; 8:0.5-4.5V; 9:NTC HT; 10:-50T90; 11:10T170; 12:PT100
B1 Offset	-	-9999-9999 F: 0	-	B1 probe offset.
B1 Min	-	-3276.8- 3276.8 F: 0	-	B1 minimum reference for active probes.
B1 Max	-	-3276.8- 3276.8 F: 1000.0	-	B2 maximum reference for active probes.
Alarm Delay	-	0-32000 F: 60	s	B1 probe alarm Delay.

10.13.2 B4 to B5 Probes

```

I/O Config
Analog input B00
Probe type:      NTC
Offset:          0000.0
                  0000.0
                  1000.0

Alarm delay:     00060s
    
```

Parameter:	SP	Range/F.:	Unit	Description
B4 Probe type	-	0-12 F: 0	-	B4, B5 probe type definition. 0:NTC; 1:PT1000; 5:ON/OFF
B1 Offset	-	-9999-9999 F: 0	-	B4, B5 probe offset.
B1 Min	-	-3276.8-3276.8 F: 0	-	Not Used
B1 Max	-	-3276.8-3276.8 F: 1000.0	-	Not Used
Alarm Delay	-	0-32000 F: 60	s	B4, B5 probe alarm Delay.

10.13.3 ID1 to ID8 Digital Inputs

```

I/O Config
Digital Inputs 1-4
  R  A/M  M  Value
DI1: 0 Auto 0 0
DI2: 0 Auto 0 0
DI3: 0 Auto 0 0
DI4: 0 Auto 0 0
    
```

Parameter:	SP	Range/F.:	Unit	Description
R	-	0/1	-	IDx read value (Real value).
A/M	-	Auto/ Manual	-	IDx mode. Automatic or Manual mode.
M	-	0/1	-	IDx manual value for manual mode.
Value	-	0/1	-	IDx result used for control.

10.13.4 Analog Outputs AO1 to AO4

```

I/O Config
Analog Output 1 OK
Mode: 0-10V
ModDutyCycleIR: 000.0 %
PeriodDR: 0000 x0.01s
TriacGateMin: 007.0 %
TriacGateMax: 093.0 %
TriacGateWD: 02.0 ms
  
```

```

I/O Config
Analog Output 2 OK
Mode: 0-10V
ModDutyCycleIR: 000.0 %
PeriodDR: 0000 x0.01s
TriacGateMin: 007.0 %
TriacGateMax: 093.0 %
TriacGateWD: 02.0 ms
  
```

```

I/O Config AO 3
Enabled: 1 OK
Mode: 0-10V
ModDutyCycleIR: 000.0 %
PeriodDR: 0000 x0.01s
TriacGateMin: 007.0 %
TriacGateMax: 093.0 %
TriacGateWD: 20.0 ms
  
```

```

I/O Config AO 4
Enabled: 1 OK
Mode: 0-10V
ModDutyCycleIR: 000.0 %
PeriodDR: 0000 x0.01s
TriacGateMin: 007.0 %
TriacGateMax: 093.0 %
TriacGateWD: 02.0 ms
  
```

Parameter:	SP	Range/F.:	Unit	Description
Enabled	-	0/1 F: 1	-	Only for Menu AO3-4. Analog output: Enabled=1
OK/Error	-	OK/Error	-	Configuration OK or Error. If Error, configuration is wrong.
Mode	-	0-4*	-	A0x output mode. 0:0-10V;1:PWM Sync ; 2:Phase Cutt Sync; 3:CONV010NONOFFFCS3; 4:PWM Slew Rate.
ModDutyCycleIR	-	0-100.0 F: 0	%	Modulation Duty Cycle for PWM modes.
PeriodDR	-	0-9999 F: 0	0.01s	Modulation Period for PWM modes.
TriacGateMin	-	0-100.0 F: 7.0	%	Minimum opening for phase cutting.
TriacGateMax	-	0-100.0 F: 93.0	%	Maximum opening for phase cutting.
TriacGateWD	-	0-99.9 F: 2.0	ms	Phase cutting pulse duration.

*Factory setting:

Analog Output	Mode
AO1	0: 0-10V
AO2	0: 0-10V
AO3	1: PWM Sync
AO4	2: Phase Cut Sync

Note:

Analog outputs are used and must be configured in pairs AO1/AO2 and AO3/AO4.
If 0-10V is used on AO1(AO3) it must be used on AO2(AO4) as well.

10.13.5 DO1 to DO8 Digital Outputs

```

I/O Config
Digital Outputs 1-4
      A/M      M      Auto
DO1: Auto  0    0
DO2: Auto  0    0
DO3: Auto  0    0
DO4: Auto  0    0
  
```

Parameter:	SP	Range/F.:	Unit	Description
A/M	-	Auto/ Manual	-	DOx mode. Automatic or Manual mode.
M	-	0/1	-	DOx manual value for manual mode. Please use manual mode carefully. Please note DOx Relay is connected to some power element like compressor.
Auto	-	0/1	-	DOx output from pCO control. 1=switch On

10.13.6 pCOe Configuration

Configuration of expansion board.

```

I/O Config.
pCOe number:      001
Enabled: 0
      Online
Offline alr delay:030s
Analog input type
Ch 1&2 :   Carel NTC !
Ch 3&4 :   Carel NTC !
  
```

Parameter:	SP	Range/F.:	Unit	Description
pCOe Enabled	-	0/1 F: 0	-	Enabling pCOe. Do not activate until pCOe is HW connected.
pCOe Online	-	Online Offline	-	pCOe connection status.
Offline alr delay	-	0-999 F: 30	s	Delay before Offline status of pCOe.
Analog input type Ch1&2	-	0-6 F: 0	-	Type of analog input B1/2 pCOe. 0:Carel NTC; 1:0..1V; 2:0..20mA; 3:4.. 20mA; 4:0..5V; 5:0.5.. 4.5 V; 6: NTC-HT
Analog input type Ch3&4	-	0-6 F: 0	-	Type of analog input B3/4 pCOe. 0:Carel NTC; 1:0..1V; 2:0..20mA; 3:4.. 20mA; 4:0..5V; 5:0.5.. 4.5 V; 6: NTC-HT

10.13.7 pCO_e Limits B1 to B4 (analog input)

```

I20 Config.
pCOe number:      001

Analog input limits
Ch 1 Min:         000.0
Ch 1 Max:         010.0
Ch 2 Min:         000.0
Ch 2 Max:         010.0
  
```

```

I20 Config.
pCOe number:      001

Analog input limits
Ch 3 Min:         000.0
Ch 3 Max:         010.0
Ch 4 Min:         000.0
Ch 4 Max:         010.0
  
```

Parameter:	SP	Range/F.:	Unit	Description
Ch x Min	-	-999.9- 999.9 F: 0	-	(B) Ch 1-4/pCO _e minimum reference for active probes.
Ch x Max	-	-999.9- 999.9 F: 0	-	(B) Ch 1-4/pCO _e maximum reference for active probes.

10.13.8 pCO_e Offset

```

I20 Config.
pCOe number:      001

Offset Ch 1:      000.0
Offset Ch 2:      000.0
Offset Ch 3:      000.0
Offset Ch 4:      000.0
  
```

Parameter:	SP	Range/F.:	Unit	Description
pCO _e Offset Ch1	-	-999.9- 999.9 F: 0	-	Bx/pCO _e offset/calibration

10.13.9 pCO_e Offline Setting

Configuration of outputs when pCO_e goes Offline.

```

I20 Config pCOe
pCOe number:      001
Values When Offline
DO1: 0           Enabled: 0
DO2: 0
DO3: 0
DO4: 0
AO1: 5U         Enabled: 0
  
```

Parameter:	SP	Range/F.:	Unit	Description
DO x	-	0/1 F: 0	-	pCOe DO 1-4 Offline configuration.
DO Enabled	-	0/1 F: 0	-	1=Enable all pCOe DO Offline operation.
AO1	-	0-2 F: 1	-	pCOe AO1 Offline configuration. 0=0V, 1=5V, 2=10V.
AO1 Enabled	-	0/1	-	1=Enable pCOe AO1 Offline operation.

10.13.10 pCOe ID1 to ID4 Digital Inputs

```

I/O Config pCOe
pCOe number:      001
R A/M      M      Value
Ch1: 0 Auto 0 0
Ch2: 0 Auto 0 0
Ch3: 0 Auto 0 0
Ch4: 0 Auto 0 0
  
```

Parameter:	SP	Range/F.:	Unit	Description
R	-	0/1	-	IDx/pCOe read value.
A/M	-	Auto/ Manual	-	IDx/pCOe mode. Automatic or Manual mode.
RV	-	0/1	-	ID polarity.
M	-	0/1	-	IDx/pCOe manual value for manual mode.
Value	-	0/1	-	IDx/pCOe result used for control.

10.13.11 pCOe DO1 to DO4 Digital Outputs

```

I/O Config pCOe
pCOe number:      001
Digital Outputs 1-4
A/M      M      Auto
DO1: Auto 0 0
DO2: Auto 0 0
DO3: Auto 0 0
DO4: Auto 0 0
  
```

Parameter:	SP	Range/F.:	Unit	Description
A/M	-	Auto/ Manual	-	DOx/pCOe mode. Automatic or Manual mode.
M	-	0/1	-	DOx/pCOe manual value for manual mode. Please use manual mode carefully. Please note DOx Relay is connected to some power element.
Auto	-	0/1	-	DOx/pCOe output from pCO control.

10.13.12 I/O Config pCOe - Parameters

```
I/O Config pCOe
pCOe number: 001

pCOe Address: 02
pCOe Protocol: MBM
MBM Number: 1
```

Parameter:	SP	Range/F.:	Unit	Description
pCOe Adress	-	0-15 F: 2	-	Type of pCOe address.
pCOe Protocol	-	Carel/MBM F: MBM	-	Type of pCOe communication protocol.
MBM Number	-	1/2 F: 1	-	Type of Modbus Master 1/2 communication protocol.

10.14 Heat/Cool Circuits

10.14.1 Heat/Cool Circuits – Main Menu

Menu individual circuits HC1 to HC6 (heating circuit-hereafter HC).

```

[01] -000000
Status: Off / Auto
Room Temperature
Rq/Ac: 20000 /00.0 °C
Water Temperature
Rq/Ac: 00.0 /00.0 °C
Pump: Off Servo:000.0%
Mode: Auto 00.0
    
```

Parameter:	SP	Range/F.:	Unit	Description
Status	B212/	Off/On	-	Run H.circuit. On / Off
	I269	Auto/pAD/Heat ing/Cooling F:Auto		H.circuit mode: HCx mode selection, 0=heating, 1=cooling, 2=auto, 3=pAD Auto – HP automatic control pAD – control pAD = HP (pAD01) Heating – only (reverse) Cooling – only (direct)
Rq/Ac (Room Temperature)	A215/	6.0/32.0	°C	HCx room setpoint. /
	A216	F: 20.0 -99.9/99.9		HCx actual room temperature.
Rq/Ac (Water Temperature)	A96/	-99.9/99.9	°C	HCx control setpoint.
	A90	-99.9/99.9		HCx actual temperature.
Pump	B68	Off/On	-	HCx output relayactive.
Servo	A20	0-100	%	HCx analog output signal.
Mode (Cooling/Heati ng)	B214/B215	Auto/Manual /	-	Automatic/Manual mode.
	A217/A218	xx°C F: Auto		Manual heating/cooling setpoint temperature.

HCx menu - Press Prg → and enter to HCx Settings menu.

10.14.2 Heat/Cool Circuits – HC1 (HCx) Heating Setting

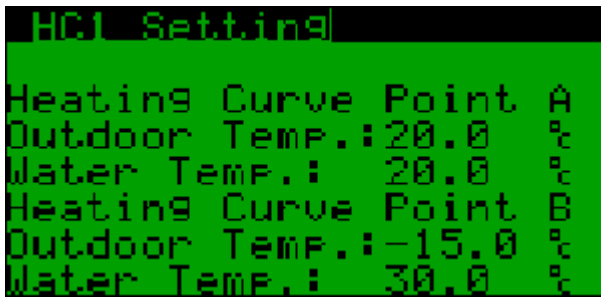

Ekviterm curve illustrates in the following figure:

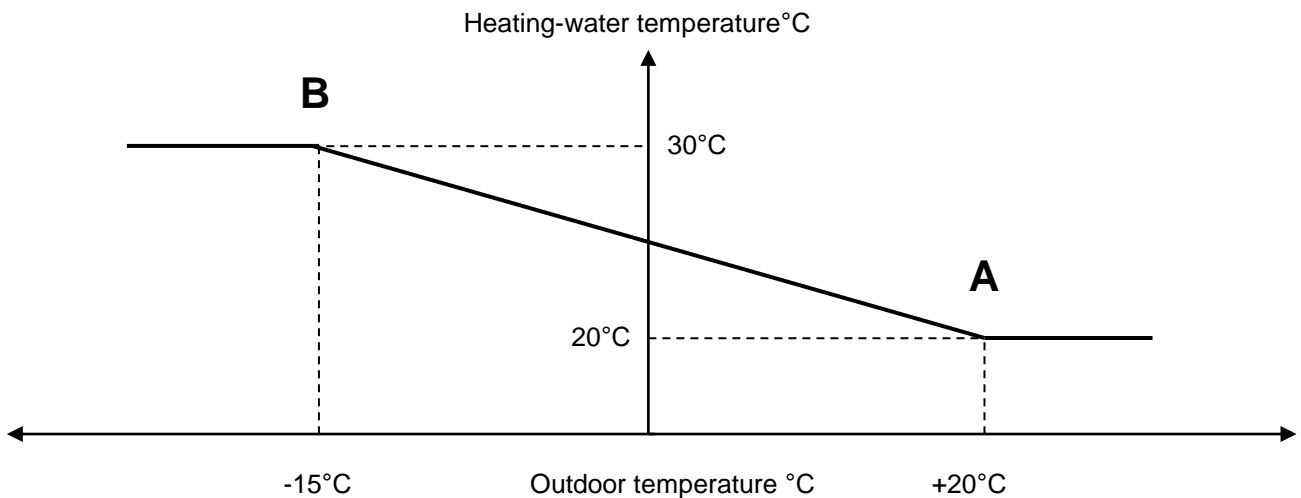

Parameter:	SP	Range/F.:	Unit	Description
Outdoor Temperature (point A)	A101	-20.0 30.0 F: 20.0	°C	Heating air temperature point A.
Water Temp. (point A)	A106	*20.0 47.5 F: 20.0	°C	Heating water temperature point A (UFH + Radiators).
Outdoor Temperature (point B)	A102	-20.0 30.0 F: -15.0	°C	Heating air temperature point B.
Water Temp. (point B)	A107	*20.0 47.5 F: 30.0	°C	Heating water temperature point B A (UFH - typical 30,0 ° C, Radiators - typical 40,0 ° C).

* Real temperature dimension in accordance with setpoint limits.

10.14.3 Heat/Cool Circuits – HC1 (HCx) Cooling Setting

This setting is enabled only for optional cooling equipment.

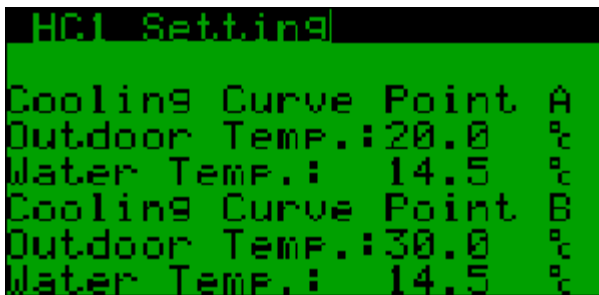

Compensation parameters in accordance with Weather in the following figure:

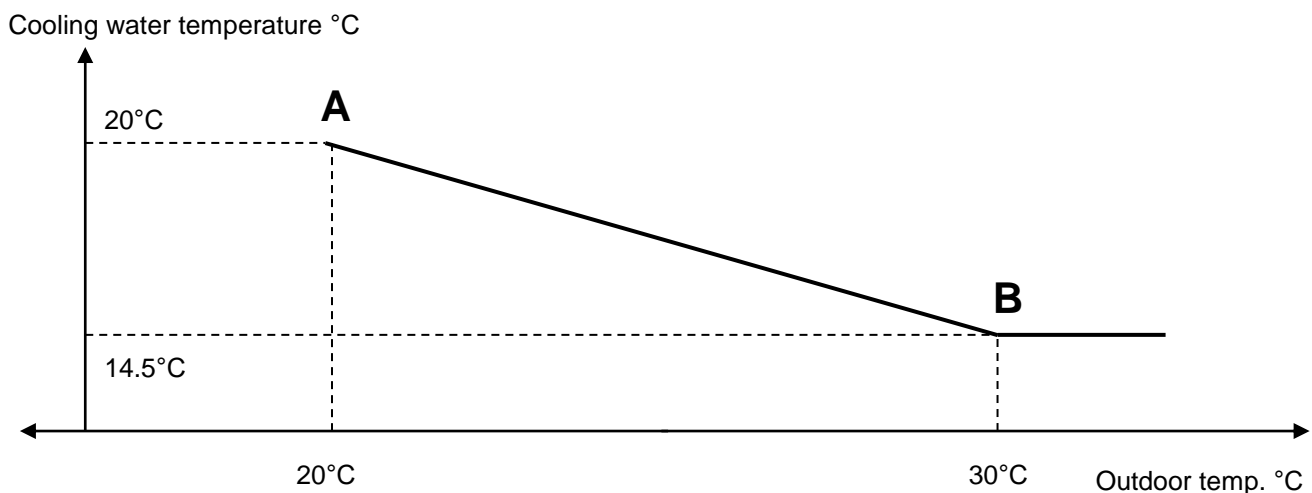

Parameter:	SP	Range/F.:	Unit	Description
Outdoor Temperature (point A)	A314	0.00 - 40.0 F: 20.0	°C	Cooling air temperature point A
Water Temp. (point A)	A315	*14.5/30.0 F: 14.5	°C	Cooling water temperature point A (typical 20,0 ° C - UFH + FanCoils).
Outdoor Temperature (point B)	A316	0.00/40.0 F: 30.0	°C	Cooling air temperature point B.
Water Temp. (point B)	A317	*14.5/30.0 F: 14.5	°C	Cooling water temperature point B (UFH - typical 18,0 ° C, FanCoils - typical 14.5 ° C).

* The current temperature range is limited by the settings during commissioning. Another restriction is enabled by Dew point protection (if is activated).

10.14.4 Heat/Cool Circuits – HC1 (HCx) Compensation Setting

HCx Setting (Heating or Cooling) - Press Prg → and enter to HCx Compensation Set.

```

HC1 Compensation Set|
pAD Active:No
Room Temp.: 00.0 °C
Room Set Temp.00.0 °C
Actual Compensation
Heating: 00.0 °C
Cooling: 00.0 °C
  
```

```

HC1 Compensation Set|
Room Temp. Probe
Not Used
Water Compensation
Heating: 05.0 °C
Cooling: 05.0 °C
Prop. Band: 02.0 °C
Integr. Time: 0000 s
  
```

Parameter:	SP	Range/F.:	Unit	Description
pAD Active	B285	Yes/No	-	pAD0x Activity – status.
Room Temp.	A216	-99.9/99.9	°C	Actual room temperature.
Room Set Temp.	A215	-99.9/99.9	°C	Setpoint room temperature.
Heating (Actual Compensation)	A325	-99.9/99.9	°C	Water temperature heating compensation.
Cooling (Actual Compensation)	A326	-99.9/99.9	°C	Water temperature cooling compensation.
Room Temp. Probe	-	B1-B5/pCO ₅ , B1-B4/pCO _e Not Used	-	Temperature probe - selection. If is pADx connected, It used inside temperature probe.
Heating (Water Compensation)	A327	-99.9/99.9 F: 5.0	°C	Max/Min - Heating compensation.
Cooling (Water Compensation)	A328	-99.9/99.9 F: 5.0	°C	Max/Min - Cooling compensation.
Prop. Band	A329	-99.9/99.9 F: 2.0	°C	PI control band to calculate water compensation.
Integr. Time	I276	0-9999 F: 0	S (sec)	PI integration time to calculate water compensation. Set "0" only for "Proporcional band" function.

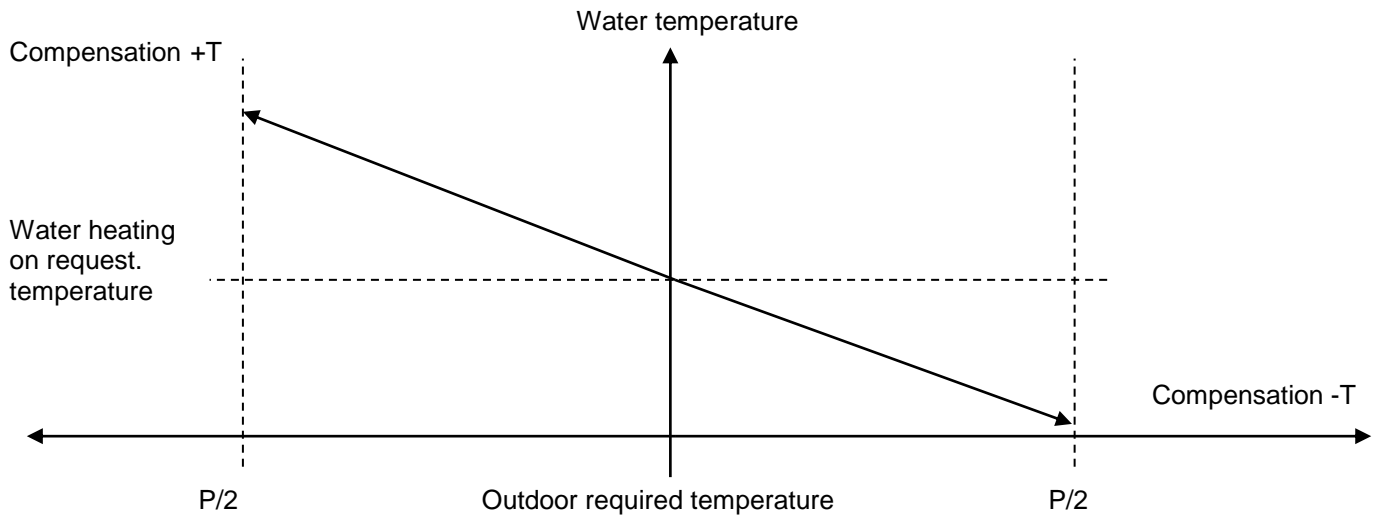
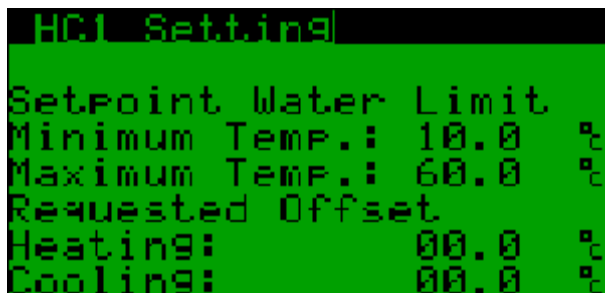

Figure above: compensation principle in accordance with room temperature. Calculated water compensation value is supplemented by the weather compensation value in accordance with required water temperature.

If room temperature probe or pAD01 controller is not installed, the system automatically assumes a room temperature of 20.0 ° C. When required room temperature is set by the user, water compensation is converted with virtual room temperature of 20.0 ° C.

10.14.5 Heat/Cool Circuits – HC1 (HCx) Setting operating range



Parameter:	SP	Range/F.:	Unit	Description
Minimum Temp.	-	-99.9/99.9 F: 10.0	°C	HCx Setpoint value - Minimum temperature water limit.
Maximum Temp.	-	-99.9/99.9 F: 60.0	°C	HCx Setpoint value - Maximum temperature water limit.
Heating (Requested Offset)	A318	-99.9/99.9 F: 0.0	°C	HCx heating water value - Offset. HCx requested value = 35.0°C Offset = 5.0 Final requested temperature of heating water = 35.0+5.0 = 40.0 (increase)
Cooling (Requested Offset)	A319	-99.9/99.9 F: 0.0	°C	HCx cooling water value – Offset (decrease).

10.14.6 Heat/Cool Circuits – HC1 (HCx) Function Setting

```

HC1 Setting
Enabled: No
Type: Mixing UFH/Rad
Hysterezis
Heating:      05.0 %
Cooling:      05.0 %
SHW Priority: Yes
Pool Priority: No
    
```

Parameter:	SP	Range/F.:	Unit	Description
Enabled	B278	Yes/No F: No	-	Function enabled.
Type (Function)	I62	0-3 F:1	-	HCx Function Type Setting. 0: None 1: Mixing UFH/Rad 2: Thermostatic 3: Hot water (SHW)
Heating (Hysterezis)	A103	-99.9/99.9 F: 5.0	°C	HCx Hysterezis in Heating mode.
Cooling (Hysterezis)	A320	-99.9/99.9 F: 5.0	°C	HCx Hysterezis in Cooling mode.
SHW Priority	B61	Yes/No F: Yes	-	Yes = SHW priority, HCx turn off. No = SHW and HCx running in same time.
Pool Priority	B279	Yes/No F: No	-	Yes = Pool priority, HCx turn off No = Pool and HCx running in same time.

10.14.7 Heat/Cool Circuits – HC1 (HCx) PID setting

```

HC1 Setting
PID Setting
P Band:      050.0 %
I Time:      100 s
D Time:      020 s
Reverse Servo: No
    
```

Parameter:	SP	Range/F.:	Unit	Description
P Band	A104	-999.9/999.9 F: 50.0	°C	Proportional band of HCx temperature control. Lower value is for faster control.
I Time	I61	0-999 F: 100	s	Integration time for HCx mixing. Lower value is for faster setpoint with risk of instability.
D Time	I60	0-999 F: 20	s	Derivation time for HCx mixing. Higher value is for faster setpoint with risk of instability.
Reverse Servo	B280	Yes/No F: No	-	Reverse switch for HCx servo running.

10.14.8 Heat/Cool Circuits – HC1 (HCx) Analog output

```

HC1 Settings
Analog Output
Min:          000.0 %
Max:          100.0 %
Off Position: 050.0 %
Manual:       000.0 %
Digital Output
Manual:       0
  
```

Parameter:	SP	Range/F.:	Unit	Description
Min	-	0-100 F: 0	%	Servo/valve minimal running limit.
Max	-	0-100 F: 100	%	Servo/valve maximal running limit.
Off Position	-	0-100 F: 50	%	Analog.output limit for valve, when HCx is off.
Manual	A321	0-100 F: 0	%	Manual valve position (permanent memory).
Manual (Digital Output)	B281	0/1 F: 0	-	DO output - Manual switch On. 0=Off, 1=On

10.14.9 Heat/Cool Circuits – HC1 (HCx) Run Setting

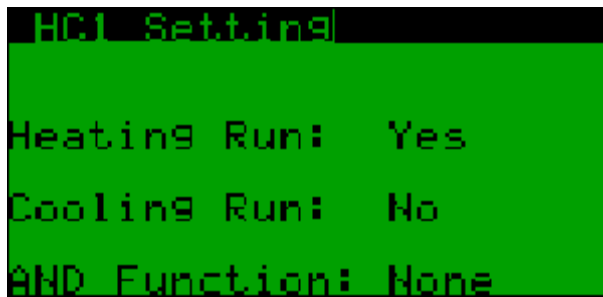

Parameter:	SP	Range/F.:	Unit	Description
Heating Run	B282	Yes/No F: Yes	-	Enables running in Heating mode. Yes = Enabled (both modes can be enabled at same time).
Cooling Run	B283	Yes/No F: No	-	Enables running in Cooling mode. Yes = Enabled
AND Function	I391	UT1/UT2/UT3/DT4/ None F: None	-	AND - Logic function setting. 0/None = Forbidden HCx can be activated with this function depending on UT1 / UT2 / UT3 / DT4.

10.14.10 Heat/Cool Circuits – HC1 (HCx) Group management

Group mode deactivates the main heating circuit if at least 1 group (heating circuit) is not active. Each HC (1-6) can be assigned to Group 1 or 2.

Group is activated if at least 1 group heating circuit is active.



Parameter:	SP	Range/F.:	Unit	Description
Group Manag.	B284	0/1 Disabled/Enabled F: Disabled	-	Group Enabled/Disabled.
Group No.	I275	1/2 F: 1	-	Group selection 1 or 2.
HCx Out	B285	Yes/No	-	HCx - Required status for running. Yes=HCx active (Cooling/Heating)
Group 1	B286	Yes/No	-	G1 - Required status for activity. Yes=active.
Group 2	B287	Yes/No	-	G2 - Required status for activity. Yes=active.

10.14.11 Heat/Cool Circuits – HC1 (HCx) HW setting (I/O)



Parameter:	SP	Range/F.:	Unit	Description
Temperature Probe	-	B1-B5/pCO ₅ B1-B4/pCO _e Not Used F: B4/pCO ₅	-	HCx Probe - Water Selection.
Output Relay	-	0-16 F: 6	-	HCx Relay - SHW Selection. 0:Not Used 1:Relay 1 /pCO ₅ , 2:Rele 2 /pCO ₅ , 3:Relay 3 /pCO ₅ , 4:Rele 4 /pCO ₅ , 5:Relay 5 /pCO ₅ , 6:Rele 6 /pCO ₅ , 7:Relay 7 /pCO ₅ , 8:Rele 8 /pCO ₅ , 9:Relay 1 /pCO _e , 10:Rele 2 /pCO _e , 11:Relay 3 /pCO _e , 12:Rele 4 /pCO _e , Optional 1-4
Digital Input	-	ID1-ID8_pCO ₅ Not Used F: ID7_pCO ₅	-	HCx DI - Selection.

10.14.12 Heat/Cool Circuits – HC1 (HCx) Alarm Output

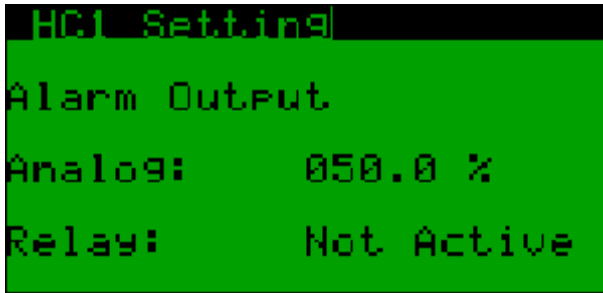

Parameter:	SP	Range/F.:	Unit	Description
Analog	-	0-100 F: 50	%	HCx Valve – Alarm position.
Relay	-	Not Active/Active F: Not Active	-	HCx Probe - Alarm Status.

10.14.13 Heat/Cool Circuits – HC1 (HCx) Name

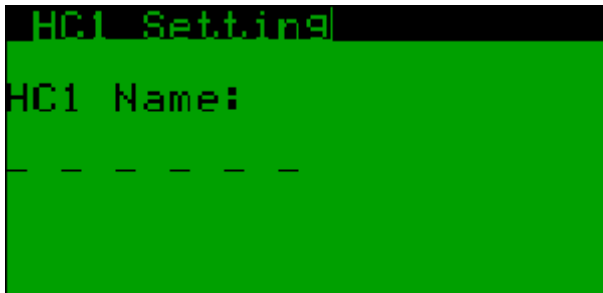

Parameter:	SP	Range/F.:	Unit	Description
HCx Name	-		-	Hcx Name - max. 6 letters. A-Z / 0-9 Name is transmitted to the NET connection.

10.14.14 Heat/Cool Circuits – HC1 (HCx) – Probe Alarm

```

HC1 Settings
Probe Alarm:    No
Alarm Memory:  No
  
```

Parameter:	SP	Range/F.:	Unit	Description
Probe Alarm	-	Yes/No	-	HCx Alarm Temperature Probe – actual status.
Alarm Memory	-	Yes/No	-	Alam Status in memory. Yes=Alarm was activated. Reset-manually change: No.

10.14.15 Heat/Cool Circuits – HC1 (HCx) – DewPoint Protection

```

HC1 Cooling Settings
DewPoint Protection:
Disabled / Not Active
DewP Offset:    00.0 °C
Rel. Humidity:  000 %
Dew Point:     00.0 °C
Temp. Limit:   00.0 °C
  
```

Parameter:	SP	Range/F.:	Unit	Description
DewPoint Protection	B288	Disabled/ Enabled F: Disabled	-	DewPoint Protection – On/Off function.
	B289	0/1		DewPoint Protection status. 0=Not Active, 1=Active
DewP Offset	A322	-99.9/99.9 F: 0.0	°C	Requested DewP Offset to avoid condensation.
Rel.Humidity	I219	0/100	%	Actual Relative Humidity (pAD11...16 Terminals probe)
Dew Point	A323	-99.9/99.9	°C	DewP calculated from relative humidity and temperature.
Temp.Limit	A324	-99.9/99.9	°C	Temperature Water Limit calculated from DewP and Offset.

**10.15 Heat/Cool Circuits – Summary table**

Table of Supervisor parameters:

Name parameter:	Acronym (pAD)	HC1	HC1	HC2	HC3	HC4	HC5	HC6
Servo (<i>Output</i>)	hc1analogout_v	A20	A89	A209	A235	A244	A253	
Outdoor Temperature (<i>point A</i>)	hc1h_air_a_v	A101	A108	A113	A122	A387	A401	
Water Temp. (<i>point A</i>)	hc1h_wtr_a_v	A106	A84	A86	A120	A388	A402	
Outdoor Temperature (<i>point B</i>)	hc1h_air_b_v	A102	A109	A114	A88	A389	A403	
Water Temp. (<i>point B</i>)	hc1h_wtr_b_v	A107	A85	A87	A121	A390	A404	
Outdoor Temperature (<i>point A</i>)	hc1c_air_a_v	A314	A330	A346	A362	A379	A405	
Water Temp. (<i>point A</i>)	hc1c_wtr_a_v	A315	A331	A347	A363	A380	A406	
Outdoor Temperature (<i>point B</i>)	hc1c_air_b_v	A316	A332	A348	A364	A381	A407	
Water Temp. (<i>point B</i>)	hc1c_wtr_b_v	A317	A333	A349	A365	A382	A408	
Ac (<i>Water Temperature</i>)	hc1temperature_v	A90	A91	A92	A93	A243	A252	
Rq (<i>Water Temperature</i>)	hc1setpoint_v	A96	A97	A98	A99	A242	A251	
Heating (<i>Actual Compensation</i>)	hc1cmpsh_v	A325	A341	A357	A374	A396	A418	
Cooling (<i>Actual Compensation</i>)	hc1cmpsc_v	A326	A342	A358	A375	A397	A419	
Heating (<i>Water Compensation</i>)	hc1h_cmps_v	A327	A343	A359	A376	A398	A420	
Cooling (<i>Water Compensation</i>)	hc1c_cmps_v	A328	A344	A360	A377	A399	A421	
Prop. Band	hc1room_pk_v	A329	A345	A361	A378	A400	A422	
Integr. Time	hc1room_ik_v	I276	I278	I280	I284	I289	I294	
Heating (<i>Requested Offset</i>)	hc1offset_v	A318	A334	A350	A366	A383	A409	
Cooling (<i>Requested Offset</i>)	hc1offsetc_v	A319	A335	A351	A367	A384	A410	
Group No.	hc1group_v	I275	I277	I279	I283	I288	I293	
Enabled	hc1enabled_v	B278	B436	B298	B307	B316	B326	
Type (<i>Function</i>)	hc1looptype_v	I62	I65	I68	I69	I285	I290	
Heating (<i>Hysteresis</i>)	hc1hyst_v	A103	A111	A115	A118	A385	A411	
Cooling (<i>Hysteresis</i>)	hc1hystc_v	A320	A336	A352	A368	A386	A412	
SHW Priority	hc1tuv_v	B61	B63	B65	B67	B317	B327	
Mode (<i>Cooling</i>)	hc1manualc_v	B214	B219	B222	B225	B229	B233	
Mode (<i>Heating</i>)	hc1manual_v	B215	B218	B223	B226	B230	B234	
Pool Priority	hc1pool_v	B279	B290	B299	B308	B318	B328	
P Band	hc1_pk_v	A104	A110	A116	A369	A391	A413	



Room Set Temp.	hc1roomsetpoint_v	A215	A221	A227	A233	A240	A249
Room Temp.	hc1_roomtemp_v	A216	A222	A228	A234	A241	A250
Mode (Cooling setpoint temperature)	hc1quickc_v	A217	A223	A229	A236	A245	A254
Mode (Heating setpoint temperature)	hc1quick_v	A218	A224	A230	A237	A246	A255
I Time	hc1_ik_v	I61	I64	I67	I281	I286	I291
D Time	hc1_dk_v	I60	I63	I66	I282	I287	I292
Reverse Servo	hc1servod_v	B280	B291	B300	B309	B319	B329
Manual	hc1amanual_v	A321	A337	A353	A370	A392	A414
Manual (Digital output)	hc1doutmanual_v	B281	B292	B301	B310	B320	B330
Heating Run	hc1heatingrun_v	B282	B293	B302	B311	B321	B331
Cooling Run	hc1coolingrun_v	B283	B294	B303	B312	B322	B332
AND Function	hc1andfunc_v	I391	I392	I393	I394	I395	I396
HCx Out (pAD11-16)	pad11out_v	B285	B295	B304	B313	B323	B333
DewPoint Protection	hc1dewpcontrol_v	B288	B296	B305	B314	B324	B334
DewP Offset	hc1dewpoffset_v	A322	A338	A354	A371	A393	A415
DewPoint Protection status (RB)	hc1dewpcontrolactive_v	B289	B297	B306	B315	B325	B335
Dew Point (pAD11-16)	pad11dewp_v	A323	A339	A355	A372	A394	A416
pAD Active (pAD11-16)	pad11active_v	D245	D248	D251	D254	D257	D259
Rel.Humidity (pAD11-16)	pad11humvalue_v	I219	I220	I229	I238	I247	I249
Status (Run H.circuit)	hc1on_v	B212	B216	B220	B50	B51	B52
Pump (Output active)	hc1_v	B68	B69	B70	B71	B228	B232
Temp.Limit	hc1dewplimit_v	A324	A340	A356	A373	A395	A417

10.16 Heat/Cool Circuits – SOLAR

When SOLAR function is activated, follow next menu:

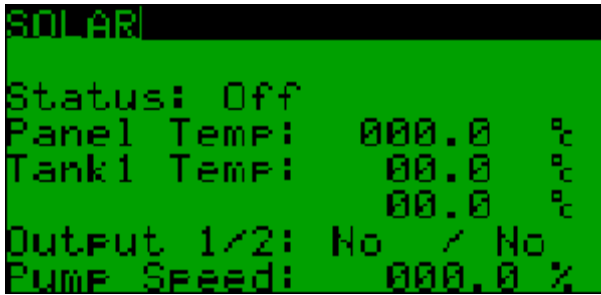

Parameter:	SP	Range/F.:	Unit	Description
Status	B235	Off/On F: Off	-	0/Off: Solar control is deactivated. 1/On: Solar control is activated.
Panel Temp	A258	-50.0/150.0	°C	Solar panel – S1 real temperature.
Tank1 Temp	A259	-50.0/99.9	°C	Solar tank1 - S2 real temperature.
Tank2 Temp	A260	-50.0/99.9	°C	Solar tank2 – S3 real temperature (If it is activated).
Output 1/2	B236 B237	Ne/Ano Ne/Ano	-	Relay status 1/2. No=Off, Yes=On.
Pump speed	A261	0-100.0	%	Heating (solar) pump speed, when Module for speed control (rotates per second) is used.

Menu: Heat/Cool Circuits / Solar → Press Prg → Entrance to Heat/Cool Circuits / Solar / Main Setup menu:

10.16.1 Heat/Cool Circuits – Solar Main Setup

```

Solar Main Setup
Solar Type: simple
Diff ON : 006.0 °C
Diff OFF: 002.0 °C
S2 max : 095.0 °C
S3 max : 095.0 °C
1st time: 005min
2nd time: 020min
  
```

Parameter:	SP	Range/F.:	Unit	Description
Solar Type	I390	simple 2crc-swi (3cv) 2crc-pump F: simple	-	Solar panels (collectors) configuration.
Diff ON	A142	-999.9/999.9 F: 6	°C	Difference between Solar panel and tank, when start Solar charging. Heating (solar) pump run in minimal speed (for this value).
Diff OFF	A143	-100/200 F: 2	°C	Difference between Solar panel and tank to complete Solar charging (switched off). Heating (solar) pump run in maximal speed (for this value).
S2 max	A144	-100/200 F: 95	°C	S2 maximal temperature for Solar charging. When S2 value is reached, the charging switches to the 2nd Tank or the charging is switched off.
S3 max	A423	-100/200 F: 95	°C	S3 maximal temperature for Solar charging. When S3 value is reached, the charging is switched off.
1st time	I338	0-530 F: 5	min	Operation Time for run of heating (solar) pump, when Tank 1 heating.
2nd time	I339	0-530 F: 20	min	Operation Time for run of heating (solar) pump, when Tank 2 heating. After end of time, switches to Tank 1.

10.16.2 Heat/Cool Circuits – Solar Main Setup - Pump

Pump configuration with speed control (rotate per second).

```
Solar Main Setup
Analog Min:      020.0 %
Analog Max:      100.0 %
Analog Out:      000.0 %

S1Max Temp.:    110.0 °C
Delay Off:       060s
```

Parameter:	SP	Range/F.:	Unit	Description
Analog Min	A424	0-100.0 F: 20	%	Minimal speed value.
Analog Max	A425	0-100.0 F: 100	%	Maximal speed value.
Analog Out	-	0-100.0	%	Actual status speed.
S1 max Temp	A528	-999.9/999.9 F: 110	°C	Maximal panel temperature for heating (solar) pump start.
Delay Off	I74	0-999 F: 60	s	Required shutdown delay time (heating/solar pump).

10.16.3 Heat/Cool Circuits – Solar Main Setup - Probes

Temperature probes - HW configuration.

```
Solar Main Setup
Probe S1 Selection:
Not Used
Probe S2 Selection:
Not Used
Probe S3 Selection:
Not Used
```

Parameter:	SP	Range/F.:	Unit	Description
Probe S1 Selection	-	B1-B5/pCO ₅ , B1-B4/pCO _e Not Used F: Not Used	-	S1 temperature probe configuration for solar panel when it is installed. S1 = panels probe NTC-HT, all inputs Pt1000, only B4/pCO ₅ , B5/pCO ₅ Necessary configuration in section: „I/O Configuration”
Probe S2 Selection	-	B1-B5/pCO ₅ , B1-B4/pCO _e Not Used F: Not Used	-	S2 temperature probe configuration for Tank1 when it is installed.
Probe S3 Selection	-	B1-B5/pCO ₅ , B1-B4/pCO _e Not Used F: Not Used	-	S3 temperature probe configuration for Tank2 when it is installed.

10.16.4 Heat/Cool Circuits – Solar Main Setup - Relay

HW Relay configuration.

```
Solar Main Setup
Enabled: No
Relay R1 Selection:
Not Used
Relay R2 Selection:
Not Used
R1 Pulse on R2 Change:
060 s
```

Parameter:	SP	Range/F.:	Unit	Description
Enabled	B433	Yes/No F: No	-	Solar control enabled.
Relay R1	-	R1-R8/pCO5 R1-R4/pCOe Optional 1-4 Not Used F: Not Used	-	R1 relay selection.
Relay R2	-	R1-R8/pCO5 R1-R4/pCOe Optional 1-4 Not Used F: Not Used	-	R2 relay selection.
R1 Pulse on R2 Change	I404	0-999 F: 60	s	Pump stop time when switching the 3-way valve to prevent mixing of water between 1/2 tanks.

```

Solar Main Setup
R1 Manual: No
R2 Manual: No
Analog Manual:000.0 %
  
```

Parameter:	SP	Range/F.:	Unit	Description
R1 Manual	B434	Yes/No F: No	-	Manual relay switching R1. Yes=switched
R2 Manual	B435	Yes/No F: No	-	Manual relay switching R2. Yes=switched
Analog Manual	A426	0-100 F: 0	%	Manual setting of required solar pump speed.

10.16.5 Heat/Cool Circuits – Solar Main Setup - info Alarm

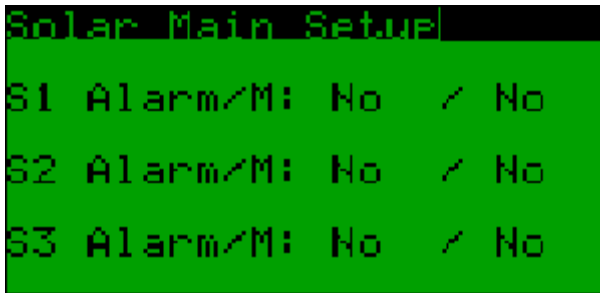

Parameter:	SP	Range/F.:	Unit	Description
S1 Alarm/M	B364	Yes-No/Yes-No F: No/No	-	Alarm/Memory Alarm: Displays “Yes”, alarm S1 Solar is active. Memory: Yes= Alarm in memory. Reset - you need to enter manually “No”. If Alarm is active, Solar function is deactivated.
S2 Alarm/M	B365	Yes-No/Yes-No F: No/No	-	Alarm/ Memory Alarm: Displays “Yes”, alarm S2 Solar is active. Memory: Yes= Alarm in memory. Reset - you need to enter manually “No”. If Alarm is active, Solar function is deactivated.
S3 Alarm/M	B366	Yes-No/Yes-No F: No/No	-	Alarm/ Memory Alarm: Displays “Yes”, alarm S3 Solar is active. Memory: Yes= Alarm in memory. Reset - you need to enter manually “No”. If Alarm is active, Solar function is deactivated.

10.17 Heat/Cool Circuits – Pool

If Pool heating function is activated, follow next menu:

```

POOL
Status: Off
Pool Requested: 029.0 °C
Pool Temp: 000.0 °C
Heating Out: No
Filtration Out: No
    
```

Parameter:	SP	Range/F.:	Unit	Description
Status	B238	Off/On F: Off	-	Off: Pool function deactivated. On: Pool function activated.
Pool Requested	A15	-100/200 F: 29	°C	Requested water pool temperature by user.
Pool Temp	A262	-99.9/99.9	°C	Real temperature pool water.
Heating Out	B239	Yes/No	-	R1 output. Yes=Pool heating is active.
Filtration Out	B240	Yes/No	-	R2 output. Yes=Filtration is active.

Press PRG → entrance to Pool Main Setup menu:

10.17.1 Heat/Cool Circuits – Pool Main Setup

```

POOL Main Setup 1
Pool Setpoint: 029.0 °C
filter timer: Period
Pool Hyst: 01.0 °C
Probe Delay: 030 sec
d_in: rem dis
Filter Time: 030 min
Pause Time: 240 min
    
```

Parameter:	SP	Range/F.:	Unit	Description
Pool Setpoint	A15	-100/ 200.0 F: 29.0	°C	Requested Pool Water Temperature.
Filter timer	I343	period fro-to F: period	-	Filtration pump setting. period – periodic timer fro-to - timer programming from-to 0 = period 1 = 4x from-to
Pool Hyst	A428	0/10 F: 1	°C	Negative value of hysteresis to heating control.
Probe Delay	I344	0-999 F: 30	s	Measuring delay of temperature after filtration start.
d_in	I345	2/rem dis 1/filt on 0/heat on F: rem dis	-	Pool - Switching functions. 0=heating + filtration, 1=filtration, 2=nonactive filtration
Filter time	I346	0-533 F: 30	min	Periodic Filtration Time for section Filter Timer: "Period" .
Pause Time	I347	0-533 F: 240	min	Pause (filtration pump) between cycle in section: Filter Timer: "Period" .

10.17.2 Heat/Cool Circuits – Pool Main Setup / Offset, Time

```

POOL Main Setup
Heat Demnd Offs: 020.0%
Pool Heating Time:
060 min
Heat/Cool Time:
060 min
  
```

Parameter:	SP	Range/F.:	Unit	Description
Heat Demnd Offs	A427	0/100.0 F: 20.0	°C	Required temperature offset of Main heating circuit water.
Pool Heating Time	I348	0-999 F: 60	min	Maximal heating limit for 1 charging pool cycle.
Heat/Cool Time	I349	0-999 F: 60	min	Minimal heating/cooling time after 1 charging pool cycle.

10.17.3 Heat/Cool Circuits – Pool Filtration Timer

```

Pool Filtration Timer
Type: On/Off Period
Filter Time: 030 min
Pause Time: 240 min
1st ON 00:00 OFF 00:15
2nd ON 06:00 OFF 06:15
3rd ON 12:00 OFF 12:15
4th ON 18:00 OFF 18:15
  
```

Parameter:	SP	Range/F.:	Unit	Description
Type	I343	On/Off Period Scheduler F: On/Off Period	-	0=On/Off Period: Filtration pump run in continuous on/off period. 1=Scheduler (Timer): Filtration pump run in accordance with time program.
Filter Time	I346	0-533 F: 30	min	On-Period Time setting. Filtration pump running in 1 cycle of Period in accordance with section Type: On/Off Period.
Pause Time	I347	0-533 F: 240	min	Off-Period Time setting. Pause between 1 cycle of Period where filtration pump running.
1, 2, 3, 4 On/Off	-	00:00 23:59	h:m	Scheduler – 4x programs. Time programming with factory setting (15 minutes for every programs).

10.17.4 Heat/Cool Circuits – Pool Main Setup / Inputs, priority

```

POOL Main Setup
Temp Probe Selection:
Not Used
Digital Input:
Not Used

SHW Priority: Yes
Pool H/C Priority: Yes
  
```

Parameter:	SP	Range/F.:	Unit	Description
Temp Probe Selection	-	B1-B5/pCO ₅ , B1-B4/pCO _e Not Used F: Not Used	-	Probe configuration for pool temperature measuring.
Digital Input	-	ID1-ID8_pCO ₅ ID1-ID4/pCO _e Not Used F: Not Used	-	DI - input configuration for Pool function.
SHW priority	-	Yes/No F: Yes	-	SHW setting mode. Yes = SHW have priority before Pool.
Pool H/C Priority	B209	Yes/No F: Yes	-	0=No, Pool heating together with Heat circuit (does not affect the H/C mode). 1=Yes, Pool have priority before Heat circuit (Example: Deactivates cooling mode).

10.17.5 Heat/Cool Circuits – Pool Main Setup / Relays

```

POOL Main Setup
Enabled: No
Relay R1 Selection:
Not Used
Relay R2 Selection:
Not Used
    
```

Parameter:	SP	Range/F.:	Unit	Description
Enabled	B348	Yes/No F: No	-	Enabled Pool control function.
Relay R1 Selection	-	R1-R8/pCO ₅ R1-R4/pCO _e Optional 1-4 Not Used F: Not Used	-	R1 relay selection for Pool function.
Relay R2 Selection	-	R1-R8/pCO ₅ R1-R4/pCO _e Optional 1-4 Not Used F: Not Used	-	R2 relay selection for Pool function.

10.17.6 Heat/Cool Circuits – Pool Main Setup / Relays manual

```

POOL Main Setup
R1 Manual: No
R2 Manual: No
    
```

Parameter:	SP	Range/F.:	Unit	Description
R1 manual	B407	Yes/No F: No	-	R1 relay manual activation. Yes=switched On
R2 manual	B408	Yes/No F: No	-	R2 relay manual activation. Yes=switched On

10.17.7 Heat/Cool Circuits – Pool Main Setup / Alarm

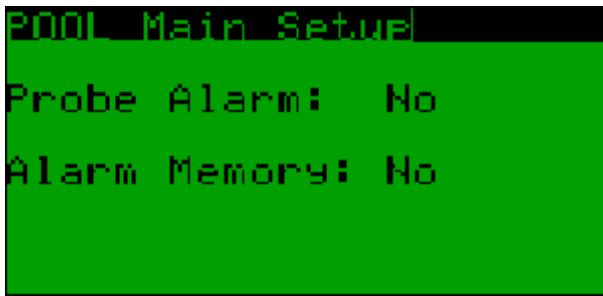

Parameter:	SP	Range/F.:	Unit	Description
Probe Alarm	B367	Yes/No	-	Actual alarm status – S1 temperature pool probe.
Alarm Memory	-	Yes/No	-	Memory alarm status – S1 temperature pool probe. Yes=alarm was active. Reset - you need to enter manually "No".

Press ESC → list to "High Temp.Protection":

10.18 Heat/Cool Circuits – High Temp.Protection (HTP)



Parameter:	SP	Range/F.:	Unit	Description
Status	B260	Off/On	-	Enabled/Disabled protection. On= active
HTP Requested	A280	-99.9/ 99.9 F:70.0	°C	Requested temperature for protection activity.
Hysterezis	A281	-99.9/ 99.9 F:5.0	°C	Negative hysteresis value for temperature protection control.
Temperature	A282	-99.9/ 99.9	°C	Actual sensor temperature selected for protection.
Active	B261	Yes/No	-	View protection activity. Yes = active protection, No = protection not activated.
Probe Alarm/M	B262/ -	Yes-No/ Yes-No	-	Alarm / Memory Alarm: Yes = Alarm is active. Memory: Yes = Memory alarm Reset - you need to enter manually "No".

Press PRG → entrance to HTP Setting menu:

10.18.1 Heat/Cool Circuits – HTP Setting



Parameter:	SP	Range/F.:	Unit	Description
Control probe	-	B1-B5/pCO ₅ , B1-B4/pCO _e None F:None	-	Probe selection.
Relay Output	-	R1-R8/pCO ₅ R1-R4/pCO _e Optional 1-4 None F: None	-	Relay selection.

Press ESC back → and list to Universal Thermostat menu:

10.19 Heat/Cool Circuits – Universal Thermostat 1 to 3

```

Universal Thermostat. 1
Status: Off
Setpoint:      20.0 °C
Hysterezis:   05.0 °C
Temperature:   00.0 °C
Active:        No
Probe Alarm/M: No /No
    
```

```

Universal Thermostat. 3
Status: Off
Setpoint:      20.0 °C
Hysterezis:   05.0 °C
Temperature:   00.0 °C
Active:        No
Probe Alarm/M: No /No
    
```

Parameter:	SP	Range/F.:	Unit	Description
Status	B263 (B266, B269)	Off/On F: Off	-	On/Off thermostat. On = active.
Setpoint	A283 (A286, A289)	-99.9/ 99.9 F: 20.0	°C	Requested temperature for thermostat switching.
Hysterezis	A284 (A287, A290)	-99.9/ 99.9 F: 5.0	°C	Negative hysteresis value for temperature protection control.
Temperature	A285 (A288, A291)	-99.9/ 99.9	°C	Actual temperature probe selected for the thermostat.
Active	B264 (B267, B270)	Yes/No	-	Thermostat activity display. Yes = Active, No = not activated
Probe Alarm /M	B265 (B268, B60) / B60	Yes-No / Yes-No	-	Alarm/Memory Alarm: Yes = Alarm is active. Memory: Yes = Memory alarm Reset - you need to enter manually "No".

Press PRG → entrance to UT1 Setting (same setting for UT2 a UT3):

10.19.1 Heat/Cool Circuits – UT1 (UT2, 3) Setting

```

UT1 Setting
Temperature Probe:
Not Used
Output Relay:
Not Used
Control Direction:
Heating (Reverse)
  
```

```

UT3 Setting
Temperature Probe:
Not Used
Output Relay:
Not Used
Control Direction:
Heating (Reverse)
  
```

Parameter:	SP	Range/F.:	Unit	Description
Temperature Probe	-	B1-B5/pCO ₅ , B1-B4/pCO _e Not Used F: Not Used	-	UTx-Probe configuration for temperature measuring.
Output Relay	-	R1-R8/pCO ₅ R1-R4/pCO _e Optional 1-4 Not Used F: Not Used	-	UTx – Relay output configuration.
Control Direction	B336 (B337,B338)	Heating (Reverse) Cooling (Direct) F:Cooling (Direct)	-	Requested setting of regulation: Heating = reverse function (requested - hysterezis) Cooling = direct function (requested + hysterezis)

Press ESC back → and list to Differential Thermostat menu:

10.19.2 Heat/Cool Circuits – Differential Tstat 4

```

Differential Tstat. 4
Status: Off
Diff. On:      85.0 °C
Diff. Off:     82.0 °C
Temp 1/2: 88.0 / 88.0 °C
Active:       No
Prb 1 Alr./M: No /No
Prb 2 Alr./M: No /No
  
```

Parameter:	SP	Range/F.:	Unit	Description
Status	B271	Off/On F: Off	-	On/Off thermostat. On = active.
Diff. On	A292	-99.9/ 99.9 F: 5.0	°C	Requested temperature difference value for switching on the thermostat.
Diff. Off	A293	-99.9/ 99.9 F: 2.0	°C	Temperature difference for thermostat switch off.
Temp 1/2	A294/ A295	-99.9/99.9 / -99.9/99.9	°C	Actual temperature 1 probe / 2 probe for thermostat.
Active	B272	Yes/No	-	Thermostat activity. Yes= Active, No= not activated
Probe 1 Alr. /M	B273/ -	Yes-No / Yes-No	-	Alarm / Memory Alarm: Yes = Alarm is active. Memory: Yes = Memory alarm Reset - you need to enter manually "No".
Probe 2 Alr. /M	B274/ -	Yes-No / Yes-No	-	Alarm / Memory Alarm: Yes = Alarm is active. Memory: Yes = Memory alarm Reset - you need to enter manually "No".

Press PRG → entrance to UT4 setting menu:

10.19.3 Heat/Cool Circuits – UT4 Setting

```

UT4 Setting
Temperature Probe 1/2:
Not Used
Not Used
Output Relay:
Not Used
Control Direction:
Heating (Reverse)
  
```

Parameter:	SP	Range/F.:	Unit	Description
Temperature Probe 1/2	-	Choice for both probes: B1-B5/pCO ₅ , B1-B4/pCO _e Not Used F: Not Used / Not Used	-	Configuration of temperature probes for temperature measurement using a differential thermostat (UT4).
Output Relay	-	R1-R8/pCO ₅ R1-R4/pCO _e Optional 1-4 Not Used F: Not Used	-	UT4 – Relay output configuration.
Control Direction	B339	Heating (reverse) Cooling (direct) F: Cooling (direct)	-	Requested setting of regulation: Heating = reverse function (requested - hysteresis) Cooling = direct function (requested + hysteresis)

Press ESC back → and list to SHW menu:

10.20 Sanitary Hot Water

Hot water – main setting.

10.20.1 SHW Configuration

```

SHW Setting
Enabled: No
Hysterezis: 05.0 °C
Minimum Temp.: 00.0 °C
Maximum Temp.: 65.0 °C
Water Temperature
Offset: 05.0 °C
    
```

Parameter:	SP	Range/F.:	Unit	Description
SHW Enabled	B275	0/1 F: 1	-	Enables generation of Hot Water. 0=No, 1=Yes
SHW Hysterezis	A12	0-99.9 F: 5.0	°C	Hysterezis of hot water preparation. On=SHW Temperature < Setpoint - Hysterezis Off=SHW Temperature >= Setpoint
SHW Minimum Temp.	A296	0-99.9 F: 0.0	°C	Minimum hot water setpoint limit.
SHW Maximum Temp.	A297	0-99.9 F: 45.0	°C	Maximum hot water setpoint limit.
SHW Offset	A298	0-99.9 F: 5.0	°C	Offset for heating water temperature setpoint. SHW setpoint = 45.0°C Offset = 5.0 Heating water setpoint = 45.0+5.0 = 50.0

10.20.2 Hot Water Timing

```

SHW Setting
Max Time SHW Mode:
060 min
Min Time H/C Mode:
060 min
Delay High Temperature
060 s
  
```

Parameter:	SP	Range/F.:	Unit	Description
Max Time SHW Mode	I53	0-999 F: 60	min	Maximum time unit is generating hot water. When hot water setpoint is not reached in this time, hot water mode is finished and heating/cooling mode is activated. When set to 0, this function is disabled.
Min Time H/C Mode	I54	0-999 F: 60	min	Minimum time unit stays in heating or cooling mode, before returning to hot water mode.
Delay High Temperature	I71	0-999 F: 60	s	Delay of heating water temperature setpoint in hot water mode after hot water mode stop.

10.20.3 SHW HW Configuration

```

SHW Setting
Temperature Probe:
81/pCO5
Output Relay:
Relay 8 /pCO5
  
```

Parameter:	SP	Range/F.:	Unit	Description
SHW Temperature Probe	-	0-9 F: 1	-	Temperature probe sensing hot water. 0=Not Used, 1=B1, 2=B2, 3=B3, 4=B4, 5=B5, 6=B1/pCOe, 7=B2/pCOe, 8=B3/pCOe, 9=B4/pCOe
SHW Output Relay	-	0-16 F: 8	-	Relay selection for hot water output. 0:Not Used 1:Relay 1 /pCO5, 2:Relay 2 /pCO5 3:Relay 3 /pCO5, 4:Relay 4 /pCO5 5:Relay 5 /pCO5, 6:Relay 6 /pCO5 7:Relay 7 /pCO5, 8:Relay 8 /pCO5 9:Relay 1 /pCOe, 10:Relay 2 /pCOe 11:Relay 3 /pCOe, 12:Relay 4 /pCOe Optional 1-4 (Do not used)

10.20.4 Antilegionella Function

```

SHM Setting
Anti Legionella Func
Active: No
Enabled: No
Setpoint: 60.0 °C
WeekDay: Friday
Start Hour: 00 h
Stop Hour: 01 h
    
```

Parameter:	SP	Range/F.:	Unit	Description
AL Active	B426	0/1	-	Function actually active. 0=No, 1=Yes
AL Enabled	B425	0/1	-	Function Enabled. 0=No, 1=Yes
AL Setpoint	A443	0-99.9 F: 60	°C	Setpoint of hot water for antilegionella function.
AL WeekDay	I397	1-7 F: 5	-	Day of the week for antilegionella function.
AL Start Hour	I398	0-23 F: 0	h	Start hour of antilegionella function.
AL Stop Hour	I399	0-23 F: 1	h	Stop hour of antilegionella function.

10.20.5 Solar Period

Hot water mode is deactivated during time of this function.

```

SHM Setting
Solar Period
Active: No
Enabled: No
Start Month: May
Stop Month: October
Start Hour: 06
Stop Hour: 16
    
```

Parameter:	SP	Range/F.:	Unit	Description
SP Active	B438	0/1	-	Solar period function actually active. 0=No, 1=Yes
SP Enabled	B437	0/1 F: 0	-	Solar period function enabled. 0=No, 1=Yes
SP Start Month	I400	1-12 F: 5	m	Start month for solar period.
SP Stop Month	I401	1-12 F: 10	m	Stop month of solar period.
SP Start Hour	I402	0-23 F: 6	h	Start hour for solar period.
SP Stop Hour	I403	0-23 F: 16	h	Stop hour of solar period.

